

Panasonic

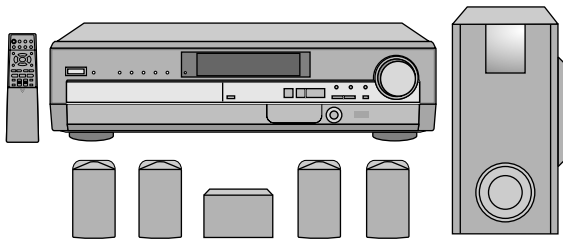

DVD Home Theater Sound System

Operating Instructions

Model No. **SC-HT67**



Before connecting, operating or adjusting this product, please read these instructions completely.
Please keep this manual for future reference.



As an ENERGY STAR® Partner, Panasonic has determined that this product meets the ENERGY STAR® guidelines for energy efficiency.

The region number of this unit is "1".
You can play DVD-Video marked "1", "ALL", or with a region number including "1".

Example:



See page 5 for details.

The servicenter list and warranty can be found on pages 34 and 35.

Dear customer

Thank you for purchasing this product.
For optimum performance and safety, please read these instructions carefully.

System	SC-HT67
Main unit	SA-HT67
Front and surround speakers	SB-AFC95
Center speaker	SB-PC89
Subwoofer	SB-W95

Operations in these instructions are described mainly with the remote control, but you can do the operations on the main unit if the controls are the same.

Getting started

CAUTION!

THIS PRODUCT UTILIZES A LASER.
USE OF CONTROLS OR ADJUSTMENTS OR PERFORMANCE OF PROCEDURES OTHER THAN THOSE SPECIFIED HEREIN MAY RESULT IN HAZARDOUS RADIATION EXPOSURE.
DO NOT OPEN COVERS AND DO NOT REPAIR YOURSELF. REFER SERVICING TO QUALIFIED PERSONNEL.

WARNING:

TO REDUCE THE RISK OF FIRE, ELECTRIC SHOCK OR PRODUCT DAMAGE, DO NOT EXPOSE THIS APPARATUS TO RAIN, MOISTURE, DRIPPING OR SPLASHING AND THAT NO OBJECTS FILLED WITH LIQUIDS, SUCH AS VASES, SHALL BE PLACED ON THE APPARATUS.

CAUTION!

DO NOT INSTALL, OR PLACE THIS UNIT, IN A BOOKCASE, BUILT-IN CABINET OR IN ANOTHER CONFINED SPACE. ENSURE THE UNIT IS WELL VENTILATED. TO PREVENT RISK OF ELECTRIC SHOCK OR FIRE HAZARD DUE TO OVERHEATING, ENSURE THAT CURTAINS AND ANY OTHER MATERIALS DO NOT OBSTRUCT THE VENTILATION VENTS.

CAUTION:

TO PREVENT ELECTRIC SHOCK MATCH WIDE BLADE OF PLUG TO WIDE SLOT, FULLY INSERT.

CAUTION:

This equipment has been tested and found to comply with the limits for a Class B digital device, pursuant to Part 15 of the FCC Rules.

These limits are designed to provide reasonable protection against harmful interference in a residential installation. This equipment generates, uses and can radiate radio frequency energy and, if not installed and used in accordance with the instructions, may cause harmful interference to radio communications. However, there is no guarantee that interference will not occur in a particular installation. If this equipment does cause harmful interference to radio or television reception, which can be determined by turning the equipment off and on, the user is encouraged to try to correct the interference by one or more of the following measures:

- Reorient or relocate the receiving antenna.
- Increase the separation between the equipment and receiver.
- Connect the equipment into an outlet on a circuit different from that to which the receiver is connected.
- Consult the dealer or an experienced radio/TV technician for help.

Any unauthorized changes or modifications to this equipment would void the user's authority to operate this device.

This device complies with Part 15 of the FCC Rules. Operation is subject to the following two conditions: (1) This device may not cause harmful interference, and (2) this device must accept any interference received, including interference that may cause undesired operation.



CAUTION

**RISK OF ELECTRIC SHOCK
DO NOT OPEN**



CAUTION: TO REDUCE THE RISK OF ELECTRIC SHOCK, DO NOT REMOVE SCREWS. NO USER-SERVICEABLE PARTS INSIDE. REFER SERVICING TO QUALIFIED SERVICE PERSONNEL.

DANGER	- VISIBLE AND INVISIBLE LASER RADIATION WHEN OPEN. AVOID DIRECT EXPOSURE TO BEAM. (FDA 21 CFR)
CAUTION	- VISIBLE AND INVISIBLE LASER RADIATION WHEN OPEN. AVOID EXPOSURE TO BEAM. (IEC60825-1)
ATTENTION	- RAYONNEMENT LASER VISIBLE ET INVISIBLE EN CAS D'OUVERTURE. EXPOSITION DANGEREUSE AU FAISCEAU.
ADVARSEL	- SYNLIG OG USYNLIG LASERSTRÅLING VED ÅBNING. UNDGÅ UDSÆTTELSE FOR STRÅLING.
VARO!	- AVATTAESSA OLET ALTTIINA NÄKYVÄÄ JA NÄKYMÄTÖN LASERSAATEILYLLE. ÄLÄ KATSO SITESSEEN.
VARNING	- SYNLIG OCH USYNLIG LASERSTRÅLNING NÄR DENNA DEL ÄR ÖPPNAD. BETRÄKTA EJ STRÅLEN.
ADVARSEL	- SYNLIG OG USYNLIG LASERSTRÅLING NÄR DEKSEL ÅPNES. UNNGÅ EKSPONERING FOR STRÅLEN.
VORSICHT	- SICHTBARE UND UNSICHTBARE LASERSTRAHLUNG, WENN ABDECKUNG GEÖFFNET. NICHT DEM STRAHLEN AUSSETZEN.
注意	- 打开时有可见及不可见激光辐射。避免激光束照射。
注意	- ここを開くと可視及び不可視のレーザー光が出ます。ヒームを直接見たり、触れないでください。 ROLS0233

(Inside of product)



The lightning flash with arrowhead symbol, within an equilateral triangle, is intended to alert the user to the presence of uninsulated "dangerous voltage" within the product's enclosure that may be of sufficient magnitude to constitute a risk of electric shock to persons.



The exclamation point within an equilateral triangle is intended to alert the user to the presence of important operating and maintenance (servicing) instructions in the literature accompanying the appliance.

Accessories

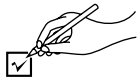

Please check and identify the supplied accessories. Use numbers indicated in parentheses when asking for replacement parts.

To order accessories contact 1-800-332-5368 or web site (<http://www.panasonic.com>).

- 1 Remote control**
(EUR7502XD0)

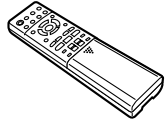

- 1 AC power supply cord**
(RJA0065-1D)

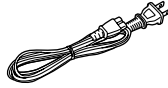

- 2 Batteries**
for remote control

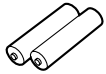

- 1 Video cable**
(RJL1P016B15A)



- 1 AM loop antenna set**
(RSA0012)

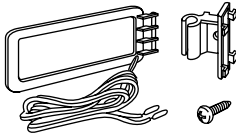

- 1 Sheet of speaker feet**
(RFA0631A-K)
Replacements sold in sets of 4.

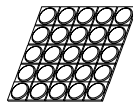

- 1 FM indoor antenna**
(RSA0006-J)



- 1 Sheet of speaker-cord stickers**
(12 stickers)
One set is extra.
The sheet cannot be purchased separately.

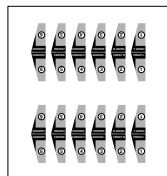

Getting started

Accessories	3
IMPORTANT SAFETY INSTRUCTIONS	4
Disc information	5
Disc handling	5
Simple setup	
STEP 1 Locating and connecting the speakers ..	6
STEP 2 Television, antennas and AC power supply cord	8
STEP 3 The remote control	9
STEP 4 Quick Setup	9
Control reference guide	10

Disc operations

Discs—Basic play	11
Using menus to play MP3 discs	12
Resume function	12
Skipping chapters or tracks	13
Fast forward and rewind—SEARCH	13
Slow-motion play/Frame-by-frame viewing	13
Starting play from a selected track	13
Disc skip/Cinema	13
Marking places to play again—MARKER	13
Discs—Convenient functions	14
A-B repeat play/Repeat play	14
Subtitles/Soundtracks/Angles	14
Using the disc manager	15
Program play/Random play	15
Using On-Screen Menu Icons	16
Common procedures	16
Progress indicator	16
Disc information/Unit information	17

Radio operations

The radio: manual tuning	18
The radio: preset tuning	19

Sound quality/sound field operations

Sound field	20
DOLBY DIGITAL/DOLBY PRO LOGIC	21
Changing sound field and quality	21
SUPER SURROUND/SEAT POSITION/CENTER FOCUS ..	22
Adjusting the bass	22

Other functions

Convenient functions	23
Muting the volume/Turning off the display	23
Timer functions	23
Using headphones	23
Changing settings	24
Common procedures	25
Entering a password (Ratings)/Changing the delay time ..	25
Using the remote control with other equipment ..	26
Operating a television/Operating a video cassette recorder ..	26
Changing the remote control code	27
Listening to an external source/	
Recording to other equipment	28
Optional antenna connections	29

Reference

Troubleshooting guide	30
Maintenance	31
Glossary	32
Language code list	32
Specifications	33
Servicenter List	34
Limited Warranty	35
Product Service	35

IMPORTANT SAFETY INSTRUCTIONS

Read these operating instructions carefully before using the unit. Follow the safety instructions on the unit and the safety precautions listed below. Keep these operating instructions handy for future reference.

Getting started

Safety

- 1. Power source**—Connect the unit to a power source of the type described in these instructions or as marked on the unit.
- 2. Polarization**—The unit is equipped with a polarized power plug where one blade is wider than the other. This safety feature ensures that the plug fits into your household AC outlet only one way. If the plug doesn't fit one way, try reversing it. If the plug still doesn't fit, contact an electrician to replace the obsolete outlet. Do not attempt to defeat the safety purpose of the plug.
- 3. Power cord protection**—Route the AC power supply cord so that it will not be walked on or pinched by items placed on or against it. Never take hold of the plug or cord with wet hands. Always grasp the plug body firmly when connecting and disconnecting it.
- 4. Overloading**—When connecting the AC power supply cord, be careful not to overload the household AC outlet, extension cord, or outlet from any other device as this can result in fire or electric shock.
- 5. Nonuse periods**—Turn the unit off when it is not in use. Unplug the unit from the household AC outlet if it is not to be used for a long time. Unplug the unit during lightning storms.
- 6. Attachments and accessories**—Use only the attachments and accessories recommended in these operating instructions.

Installation

Placement

- 1. Ventilation**—Situate the unit so that it receives proper ventilation. Do not install in a confined space such as a bookcase or cabinet. Allow at least 10 cm (4 inches) clearance from the rear of the unit. To prevent the risk of electric shock or fire due to overheating ensure curtains and other materials do not obstruct the unit's ventilation.
- 2. Foreign material**—Ensure objects and liquids do not get into the unit. Avoid exposing the unit to excessive smoke, dust, mechanical vibration, and shock.
- 3. Magnetism**—Situate the unit away from equipment and devices that generate strong magnetic fields.
- 4. Stacking**—Do not place heavy objects on top of this unit.
- 5. Surface**—Place the unit on a flat, level surface.
- 6. Carts and stands**—Use the unit only with carts and stands recommended by the manufacturer. Move carts with care. Sudden stops, excessive force, and uneven surfaces can cause carts to overturn.
- 7. Wall and ceiling mounting**—Do not mount the unit on walls or ceilings unless specified in the instructions.



Environment

- 1. Water and moisture**—Do not use the unit near water, such as near a bathtub or swimming pool. Avoid damp basements.
- 2. Heat**—Situate the unit away from heat sources, such as radiators. Do not situate where temperatures fall below 5°C (41°F) or rise above 35°C (95°F).

- 3. Power lines**—Take care when setting up an outdoor antenna that it is not near overhead power lines, electric lights, or electrical circuits, and that there is no danger of the antenna falling on power lines, electric lights, or electrical circuits. When installing an outdoor antenna, take extreme care not to touch such power lines or circuits, as contact with them can be fatal.
- 4. Outdoor antenna grounding**—If you connect an outdoor antenna, ground the antenna system to protect against voltage surges and built-up static charges. Section 810 of the National Electrical Code, ANSI/NFPA No. 70-1990, provides information about grounding of the mast and supporting structure, grounding of the lead-in wire to an antenna discharge unit, size of grounding conductors, location of antenna-discharge unit, connection to grounding electrodes, and requirements for the grounding electrode. Refer to this diagram.

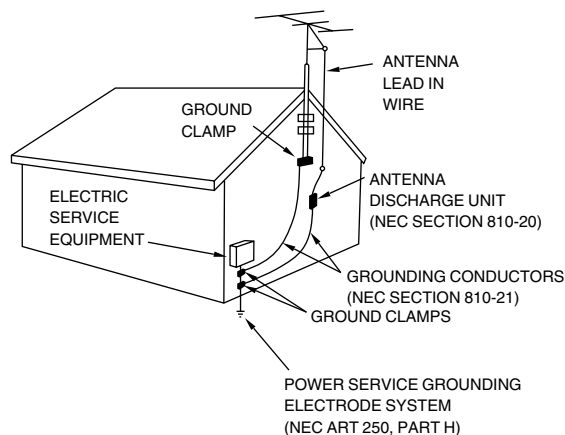

NEC—NATIONAL ELECTRICAL CODE

Maintenance

(See page 31 for details.)

Unplug the unit from the household AC outlet before cleaning. Clean with a damp cloth. Do not use abrasive pads, scouring powders, or solvents.

Service

- 1. Damage requiring service**—The unit should be serviced by qualified service personnel if:
 - (a) The AC power supply cord or the plug has been damaged; or
 - (b) Objects or liquids have gotten into the unit; or
 - (c) The unit has been exposed to rain; or
 - (d) The unit does not operate normally or exhibits a marked change in performance; or
 - (e) The unit has been dropped or the cabinet damaged.
- 2. Servicing**—Do not attempt to service the unit beyond that described in these operating instructions. Refer all other servicing to authorized servicing personnel.
- 3. Replacement parts**—When parts need replacing ensure the servicer uses parts specified by the manufacturer or parts that have the same characteristics as the original parts. Unauthorized substitutes may result in fire, electric shock, or other hazards.
- 4. Safety check**—After repairs or service, ask the servicer to perform safety checks to confirm that the unit is in proper working condition.

Discs that can be played

Disc type	Logo	Indication used in instructions
DVD-Video		DVD-V
DVD-R		
Audio CD		CD (Including CD-R/RW and discs recorded with MP3)
Video CD		VCD

Discs that cannot be played

DVD-Audio, PAL discs, DVD-ROM, DVD-RAM, CD-ROM, CDV, CD-G, +RW, DVD-RW, CVD, SVCD, SACD, Divx Video Discs and Photo CD.

Region Management Information (DVD-Video only)

This unit responds to the Region Management Information recorded on DVD-Video. This unit's region number is "1". You cannot play the disc if the region number on the DVD-Video does not correspond to the region number on the unit.

You can play discs with labels containing the region number "1" and "ALL". Read the disc's instructions carefully.

e.g.



Playing DVDs and Video CDs

The producer of these discs can control how they are played so you may not always be able to control play as described in these operating instructions. Read the disc's instructions carefully.

CD-R and CD-RW discs

This unit can play CD-DA (digital audio) and video CD format audio CD-R and CD-RW that have been finalized (a process that enables CD-R/CD-RW players to play audio CD-R and CD-RW) upon completion of recording.

It may not be able to play some CD-R or CD-RW due to the condition of the recording.

DVD-R discs

Panasonic DVD-R recorded and finalized on a Panasonic DVD video recorder are played as DVD-Video on this unit.

It may not be possible to play these discs in all cases due to the type of disc or condition of the recording.

Do not use irregularly shaped discs, such as heart-shaped. (These can damage the unit.)

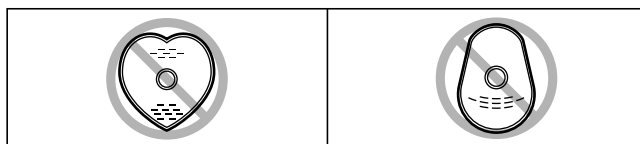

How to hold a disc

Do not touch the recorded surface.

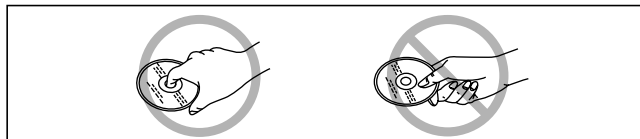

If the surface is dirty

Wipe it with a damp cloth and then wipe dry.

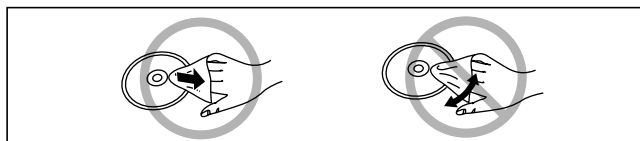

If the disc is brought from a cold to a warm environment, moisture may form on the disc

Wipe with a soft, dry, lint-free cloth before using the disc.

Handling precautions

- Do not write on the label side with a ball-point pen or other writing instrument.
- Do not use record cleaning sprays, benzene, thinner, static electricity prevention liquids or any other solvent.
- Do not attach labels or stickers to discs. (Do not use discs with exposed adhesive from tape or left over peeled-off stickers.)
- Do not use scratch-proof protectors or covers.
- Do not use discs printed with label printers available on the market.

Do not place or store discs in the following places

- Locations exposed to direct sunlight
- Humid or dusty locations
- Locations directly exposed to a heat vent or heating appliance

To prevent damage

- Load only 1 disc per tray.

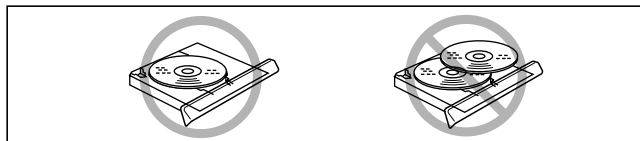

- Load discs as shown in figure.

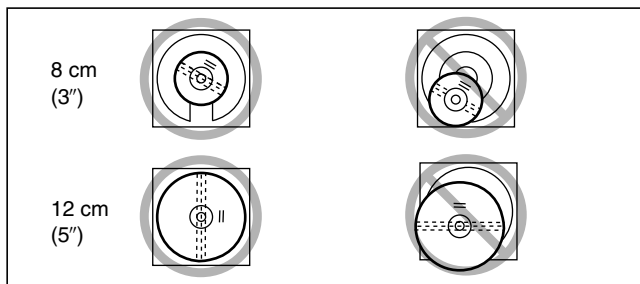

- An adaptor is not needed with 8 cm (3") discs (singles).
- Set the system on a flat, level surface.
Do not set it on top of magazines, inclined surfaces, etc.
- Do not move the system while trays are opening/closing, or when loaded.
- Do not put anything except discs in trays.
- Do not use cleaning discs or discs which are badly warped or cracked.

Simple setup

Refer also to "Speaker setup", a separate guide included with these operating instructions.

STEP 1 Locating and connecting the speakers

Use only supplied speakers

Using other speakers can damage the unit and sound quality will be negatively affected.

Set the speakers up on an even surface to prevent them from falling. Take proper precautions to prevent the speakers from falling if you cannot set them up on an even surface.

Front speakers (① Left ② Right) SB-AFC95



- The left and right speakers are the same.

Center speaker (⑤) SB-PC89



- You can also put this speaker directly under the television.
- Do not place the center speaker on the main unit as sound quality will be affected.
- Vibration caused by the center speaker can disrupt the picture if it is placed directly on the television. Put the center speaker on a rack or shelf.

Main unit

Keep your speakers at least 10 mm (13/32") away from the system for proper ventilation.

Subwoofer (⑥) SB-W95

Place near the television, on the floor or a sturdy shelf so that it won't cause vibration.

- A woofer unit is located on the side of the subwoofer. Leave 10-cm (4") clearance for it to be effective.

Place the front, center, and surround speakers at approximately the same distance from the seating position. The angles in the diagram are approximate.

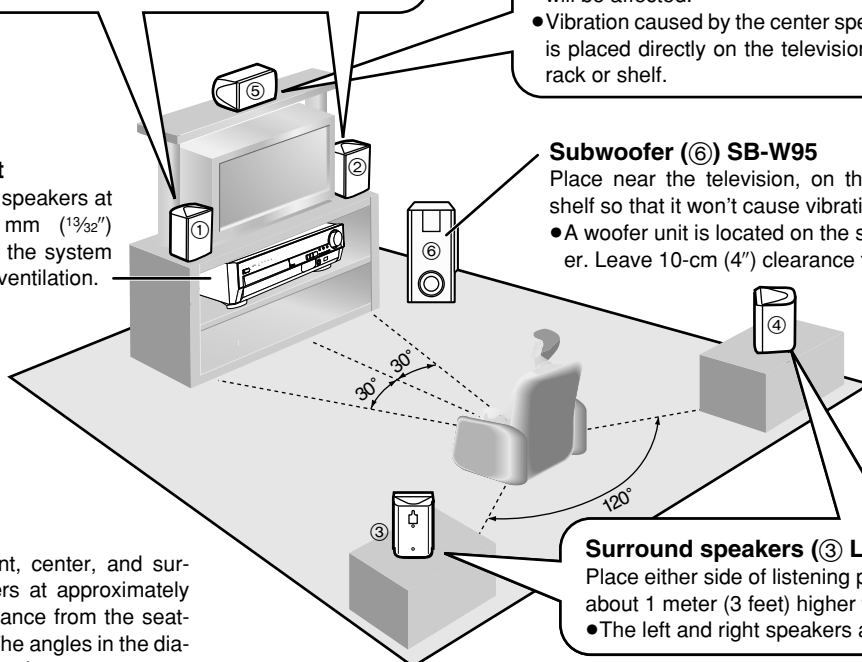

Surround speakers (③ Left ④ Right) SB-AFC95

Place either side of listening position, or slightly to the rear, about 1 meter (3 feet) higher than ear level.

- The left and right speakers are the same.

Attaching the speaker feet

Attach these speaker feet to prevent vibration causing the speakers to move or fall over.

Standing

Front (①②)/surround (③④) speakers

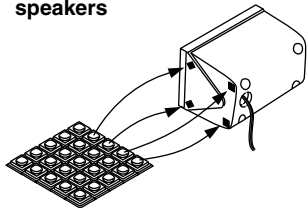

Laying down

Center speaker (⑤)

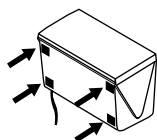

Positioning for best effect

How you set up your speakers can affect the bass and the sound field. Note the following points.

- Place speakers on flat secure bases.
- Placing speakers too close to floors, walls, and corners can result in excessive bass. Cover walls and windows with thick curtain.



Caution

- Use the speakers only with the recommended system. Failure to do so may lead to damage to the amplifier and/or the speakers, and may result in the risk of fire. Consult a qualified service person if damage has occurred or if you experience a sudden change in performance.
- Do not attempt to attach these speakers to walls using methods other than those described in this manual.

If irregular coloring occurs on your television

These speakers are designed to be used close to a television, but the picture may be affected with some televisions and setup combinations.

If this occurs, turn the television off for about 30 minutes.

The television's demagnetizing function should correct the problem. If it persists, move the speakers further away from the television.

Speaker cords

Attach the stickers to the speaker cords.

- Attach the numbered stickers to the end of the speaker cords so the numbers match the positions of the speakers shown in the diagram.

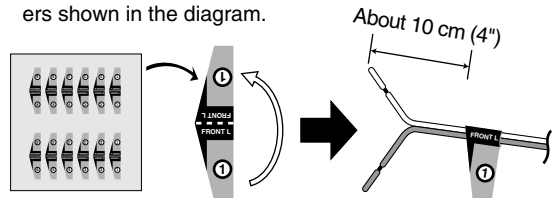

- Connect the cords to the terminals of same color so the numbers on the stickers match the numbers under the terminals.
- Never short-circuit positive (+) and negative (-) speaker wires.
- Be sure to connect only positive (red or gray) wires to positive (+) terminals and negative (black or gray with blue stripe) wires to negative (-) terminals.

Incorrect connection can damage the speakers.

- After you have completed setup and connection, wind the excess cord and keep together with string.
- The speaker nets cannot be removed.

Notes on speaker use

- You can damage your speakers and shorten their useful life if you play sound at high levels over extended periods.

Reduce the volume in the following cases to avoid damage.

- When playing distorted sound.
- When the speakers are receiving howling from a microphone or record player, noise from FM broadcasts, or continuous signals from an oscillator, test disc, or electronic instrument.
- When adjusting the sound quality.
- When turning the unit on or off.

Twist the vinyl tip and pull off.

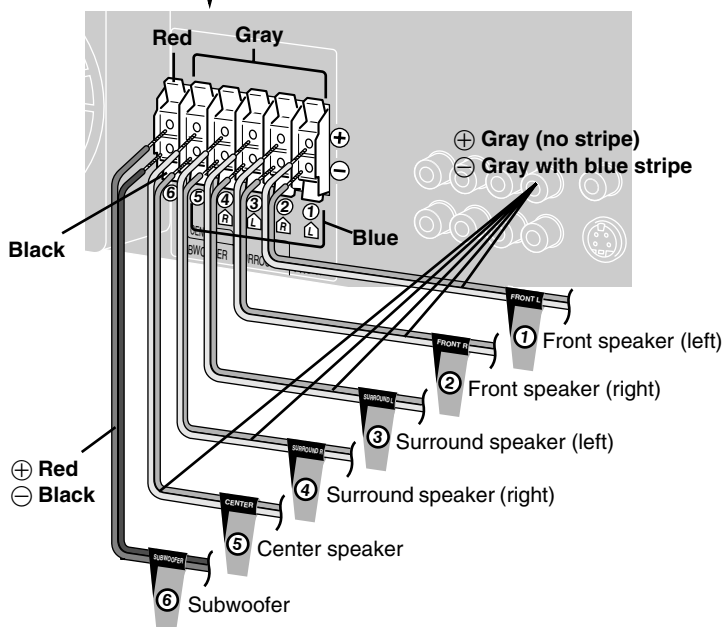
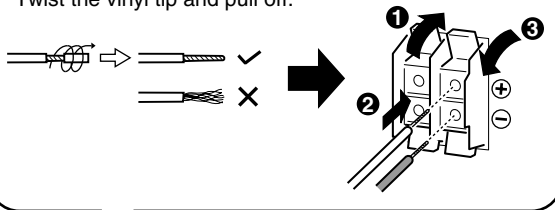

Attaching to a wall

Front and surround speakers can be attached to a wall. Attach four speaker feet to each speaker, ensuring they do not cover the holes.

Set the speaker onto screws and slide through bracket to lock into position.

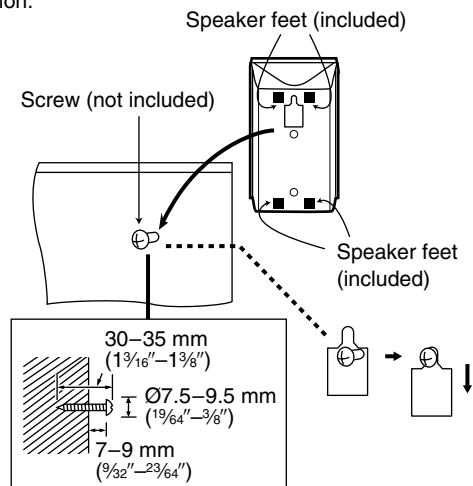

Note

The wall or pillar on which the speakers are to be attached should be capable of supporting 5 kg (11 lb.) per screw.

Attaching to speaker stands

Ensure the following conditions are met when you purchase your speaker stands.

- Observe the diameter and length of the screws and the distance between screws as shown in the diagram.
- The stands must be able to support over 5 kg (11 lb.).
- The stands must be stable even if the speakers are in a high position.

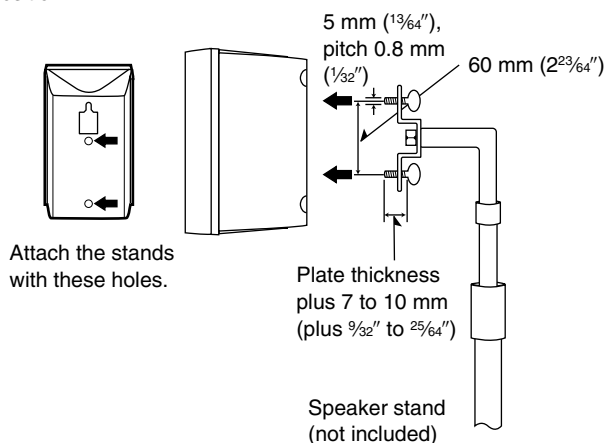

Simple setup

STEP 2

Television, antennas and AC power supply cord

Connect directly to your television.

Do not connect the unit through a video cassette recorder, because the picture may not be played correctly due to the copy guard.

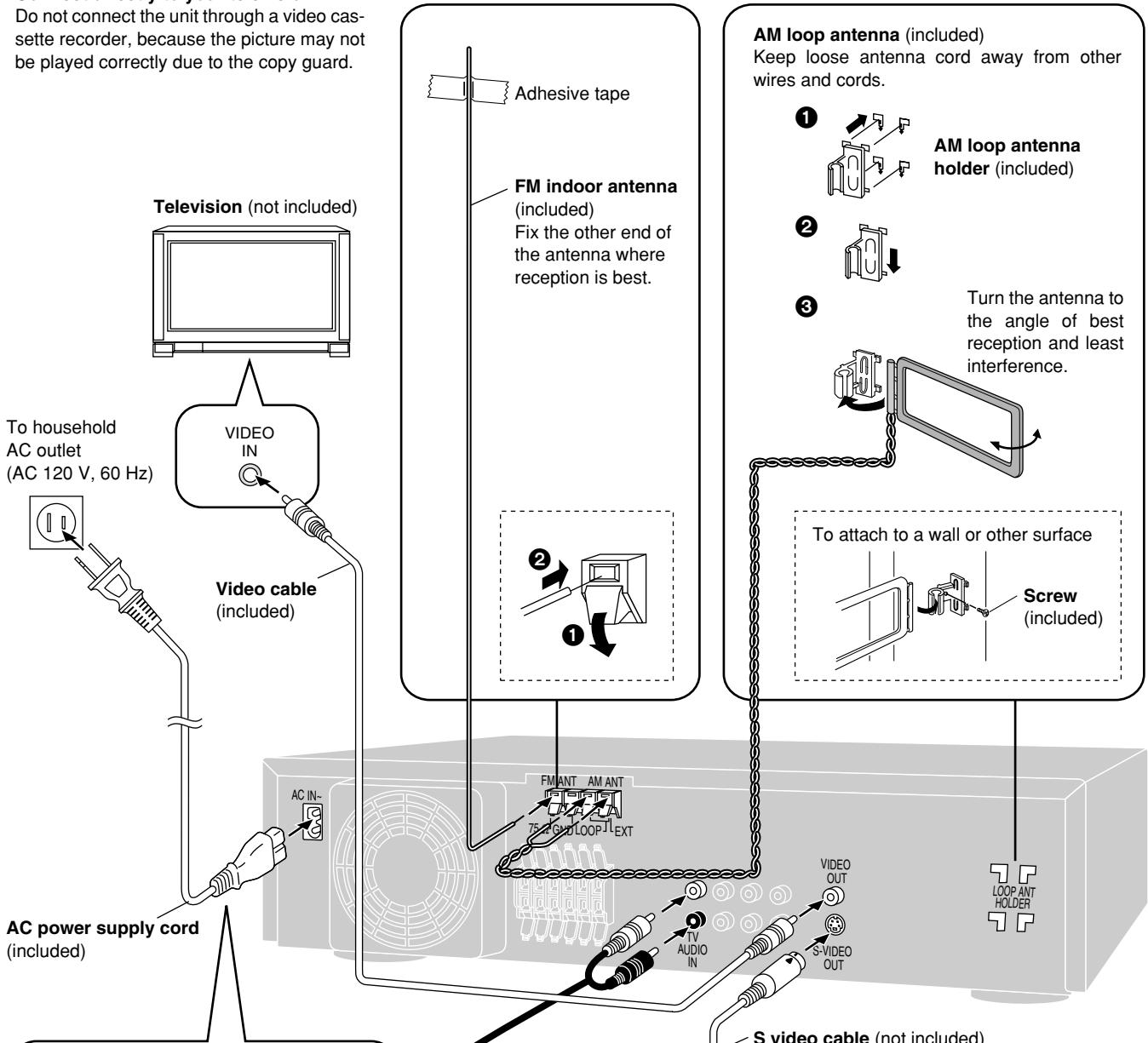

Note
The included AC power supply cord is for use with this unit only. Do not use it with other equipment.

Conserving power
The unit consumes power (approx. 0.25 W) even when it is turned off with [⏻]. To save power when the unit is not to be used for a long time, unplug it from the household AC outlet. Remember to reset the radio stations and any other memory items before using the unit again.

For your reference
Information you enter into the unit's memory remains intact for up to a week after the AC power supply cord is disconnected.

To listen to the television through this unit

TV's AUDIO OUT terminals

For better images
The S-VIDEO OUT terminal achieves a more vivid picture than the VIDEO OUT terminal by separating the chrominance (C) and luminance (Y) signals before transmitting them to the television. (Actual results depend on the television.)

TV's S-VIDEO IN terminal

STEP 3 The remote control

■ Batteries

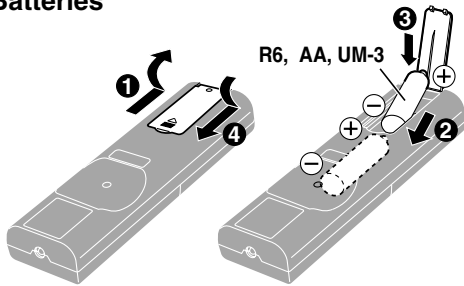

- Insert so the poles (+ and -) match those in the remote control.
- Do not use rechargeable type batteries.

Do not;

- mix old and new batteries.
 - use different types at the same time.
 - heat or expose to flame.
 - take apart or short circuit.
 - attempt to recharge alkaline or manganese batteries.
 - use batteries if the covering has been peeled off.
- Mishandling of batteries can cause electrolyte leakage which can damage items the fluid contacts and may cause a fire.

Remove if the remote control is not going to be used for a long period of time. Store in a cool, dark place.

■ Use

Aim at the sensor, avoiding obstacles, at a maximum range of 7 m (23 feet) directly in front of the unit.

STEP 4 Quick Setup

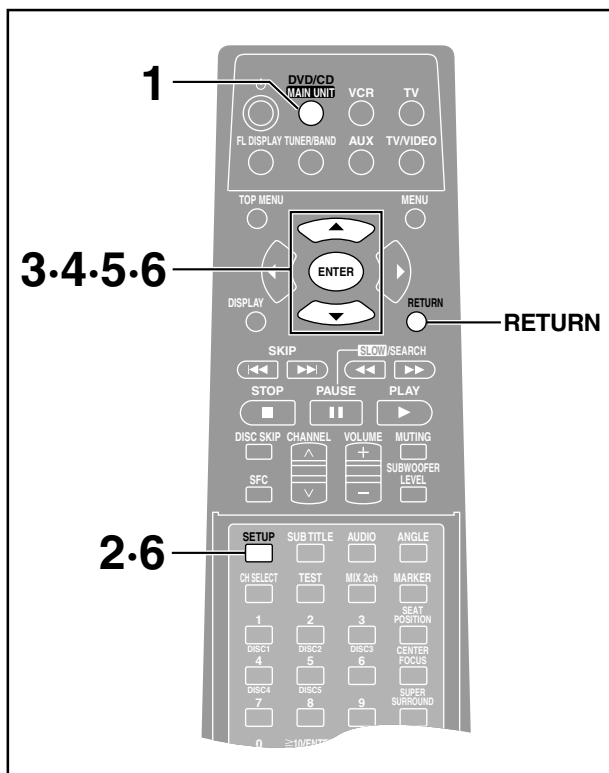

2 Press [SETUP] to show the QUICK SETUP screen.

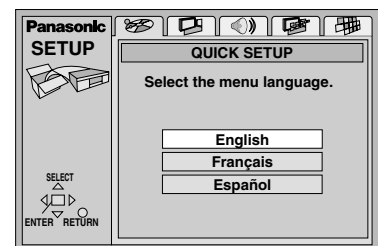

3 Press [▲, ▼] to select the menu language and press [ENTER].

4 Press [▲, ▼] to select “Yes” to continue and press [ENTER].

5 Press [▲, ▼] to select the item and press [ENTER].

- Audio Language (For setting details → page 24)
- Subtitle Language (For setting details → page 24)
- TV Aspect (For setting details → below)

6 Press [ENTER] and then [SETUP] to end the settings.

Remote control only

The **QUICK SETUP** screen appears when you press [SETUP] the first time after purchase and assists you to make necessary settings.

Preparation

Turn on the television and select the appropriate video input on the television to suit the connections for the player.

1 Press [DVD/CD] to turn on the unit.

The unit comes on automatically and “DVD/CD” is selected as the source.

To return to the previous screen

Press [RETURN].

■ TV Aspect

Select “4:3” (regular) or “16:9” (widescreen) to suit your television. If you have a regular 4:3 television, you can also select how video on some discs is shown (→ page 24, Video—TV Aspect).

• 4:3 Pan&Scan (Factory preset)

The pan and scan (the original widescreen images are converted for viewing on a regular television) version of the video is automatically selected if recorded on the disc.



• 4:3 Letterbox

The letterbox (the original widescreen images appear with black bands above and below) version of the video is automatically selected if recorded on the disc.



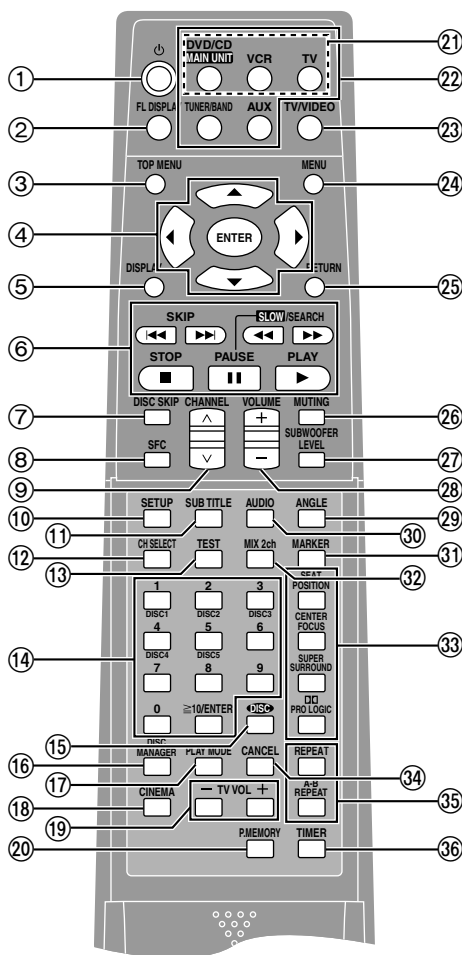

How to open the remote control

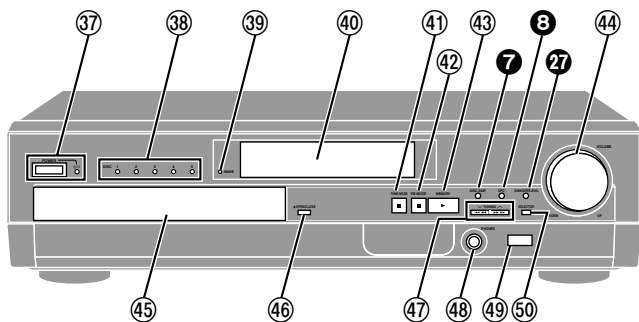
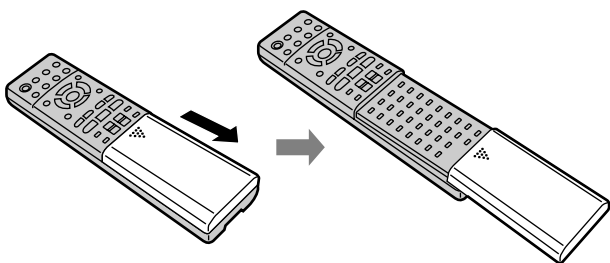

Buttons **7**, **8**, and **27** function the same as the controls on the remote control.

Remote control

Page

①	Power button [⏻]	11
②	FL display button [FL DISPLAY]	23
③	Top menu button [TOP MENU]	11, 12
④	Cursor buttons [▲, ▼, ◀, ▶]/Enter button [ENTER]	9
⑤	Display button [DISPLAY]	16
⑥	Basic operation buttons	
⑦	Disc skip button [DISC SKIP]	11
⑧	Sound field control button [SFC]	21
⑨	Channel select buttons [▲, ▼, CHANNEL]	19, 26
⑩	Initial settings button [SETUP]	9, 25
⑪	Subtitle button [SUB TITLE]	14
⑫	Speaker channel select button [CH SELECT]	21
⑬	Test button [TEST]	21
⑭	Numbered buttons (1–9, 0, ≥10/ENTER)	11
⑮	Disc button [DISC]	11
⑯	Disc manager button [DISC MANAGER]	15
⑰	Play mode button [PLAY MODE]	15
⑱	Cinema button [CINEMA]	13
⑲	TV volume buttons [– TV VOL +]	26
⑳	Position memory button [P.MEMORY]	12
㉑	Equipment buttons and indicators	
	Select the equipment you want to operate.	
	• Press [DVD/CD] to operate this unit.	
	• Press [VCR] to operate a video cassette recorder.	
	• Press [TV] to operate a television.	
	These buttons light for a few seconds to indicate the remote control mode.	
㉒	Input select buttons	
	[DVD/CD, MAIN UNIT, VCR, TV, TUNER/BAND, AUX]	
	Pressing [DVD/CD] or [TUNER/BAND] also turns the unit on.	
	[TUNER/BAND] also switches radio bands.	
㉓	TV/Video button [TV/VIDEO]	26
㉔	Menu button [MENU]	11, 12
㉕	Return button [RETURN]	9, 25
㉖	Muting button [MUTING]	23
㉗	Subwoofer level button [SUBWOOFER LEVEL]	22
㉘	Volume buttons [+ , – , VOLUME]	11, 18
㉙	Angle button [ANGLE]	15
㉚	Audio button [AUDIO]	15
㉛	Marker button [MARKER]	13
㉜	Mix 2ch button [MIX 2ch]	21
㉝	Sound field and effect buttons	21, 22
㉞	Cancel button [CANCEL]	13
㉟	Repeat buttons [REPEAT, A-B REPEAT]	14
㊱	Timer button [TIMER]	23

Main unit

㊲	Standby/on switch [POWER]	11
	Press to switch the unit from on to standby mode or vice versa.	
	In standby mode, the unit is still consuming a small amount of power.	
	Standby/on indicator [⏻]	
	When the unit is connected to the AC mains supply, this indicator lights red in standby mode and lights green when the unit is turned on.	
㊳	Disc indicators [DISC 1–5]	11
㊴	Wake timer indicator [WAKE]	23
㊵	Display	
㊶	Stop, tune mode button [■, TUNE MODE]	11, 18
㊷	Pause, FM mode button [⏸, FM MODE]	11, 18
㊸	Play, memory button [▶, MEMORY]	11, 19
㊹	Volume control [VOLUME, DOWN, UP]	11, 18
㊺	Disc tray	11
㊻	Open/close button [▲ OPEN/CLOSE]	11
㊼	Skip/search, tuning buttons	
	[◀◀/▶▶, ▶▶/▶▶, ▼ TUNING ▲]	13, 18
㊽	Headphone jack [PHONES]	23
㊾	Remote control signal sensor	
㊿	Input select button [SELECTOR]	11

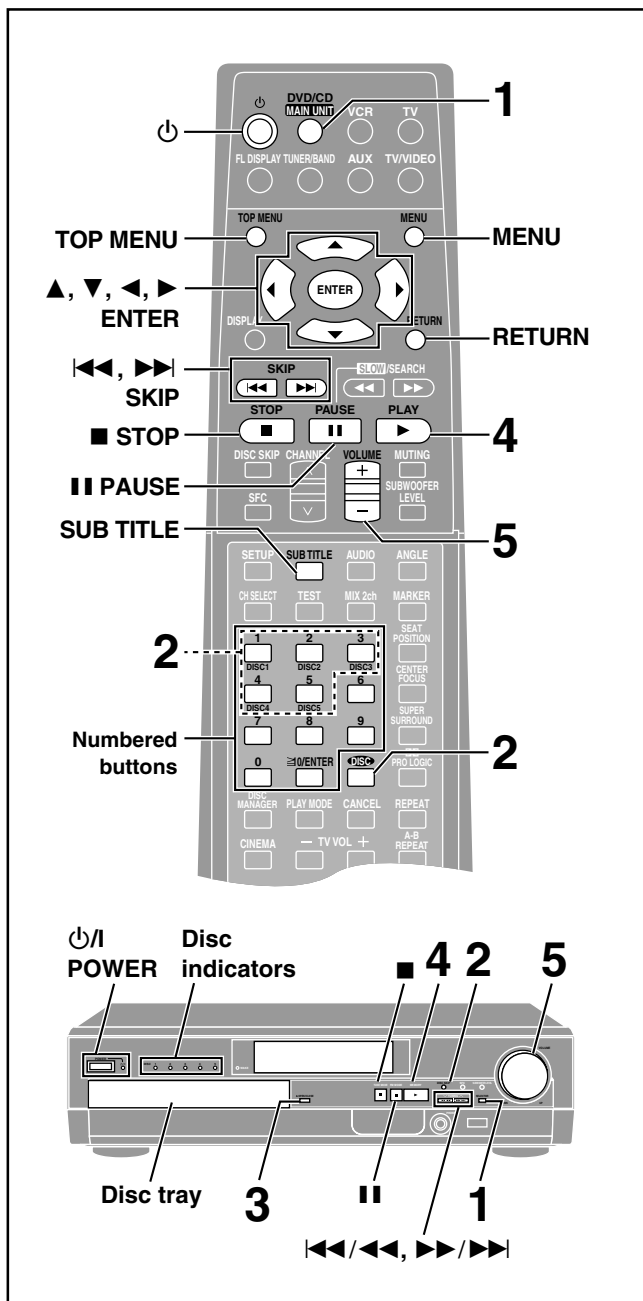

DVD-V **CD** **VCD**

Preparation

- Turn on the television and select the appropriate video input on the television to suit the connections for the player.
- Press [POWER] to turn on the unit.

1 Press [SELECTOR] to select “DVD/CD” as the source.

Each time you press the button:
DVD/CD → FM → AM → TV → VCR → AUX

Remote control: Press [DVD/CD].

2 Press [DISC SKIP] to select a tray.

The indicator lights.
 Play starts if a disc is in the tray. (One touch play)

Remote control:

Press [DISC] and then press [1]–[5] corresponding to the required tray.

3 Press [▲] to open the disc tray and insert a disc.

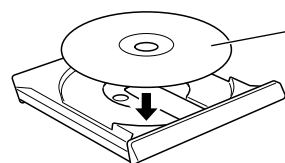

Press again to close and start play.

Repeat steps 2 and 3 to insert other discs.

4 If play doesn't start after step 3 Press [▶] (PLAY).

CD (MP3 discs)

Group and track names are displayed on the television. Press [SUB TITLE] to change the display.

Lights during play.

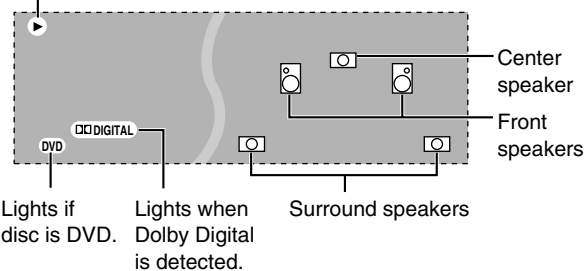

5 Adjust the volume.

■ To stop play

Press [■] (→ page 12, Resume function).

■ To pause play

Press [⏸] during play.
 Press [▶] (PLAY) to restart play.

Note

- If “⊘” appears on the television The operation is prohibited by the unit or disc.
- The disc continues to rotate while the menu is displayed even after you finish playing an item. Press [■] when you finish to preserve the unit's motor and your television screen.
- Volume may be lower when playing DVDs than when playing other discs or during television broadcasts. If you turn the volume up, be sure to reduce the volume again before playing other sources so that a sudden increase in output does not occur.

When a menu appears on the television

DVD-V **VCD**

Remote control only

Press the numbered buttons to select an item.

To select a 2-digit number

Example: To select item 23, press [≧10/ENTER] → [2] → [3].

- When playing DVDs, you can also use [▲], [▼], [◀], [▶] to select items. Press [ENTER] to confirm your selection.

Play of the selected item now begins.

Other buttons used to operate menus

Read the disc's instructions for further details about operation.

[▶▶]: Shows the next menu.

[◀◀]: Shows the previous menu.

[RETURN]: Shows the menu screen. **VCD**

[TOP MENU]: Shows the first menu screen. **DVD-V**

[MENU]: Shows the menu screen. **DVD-V**

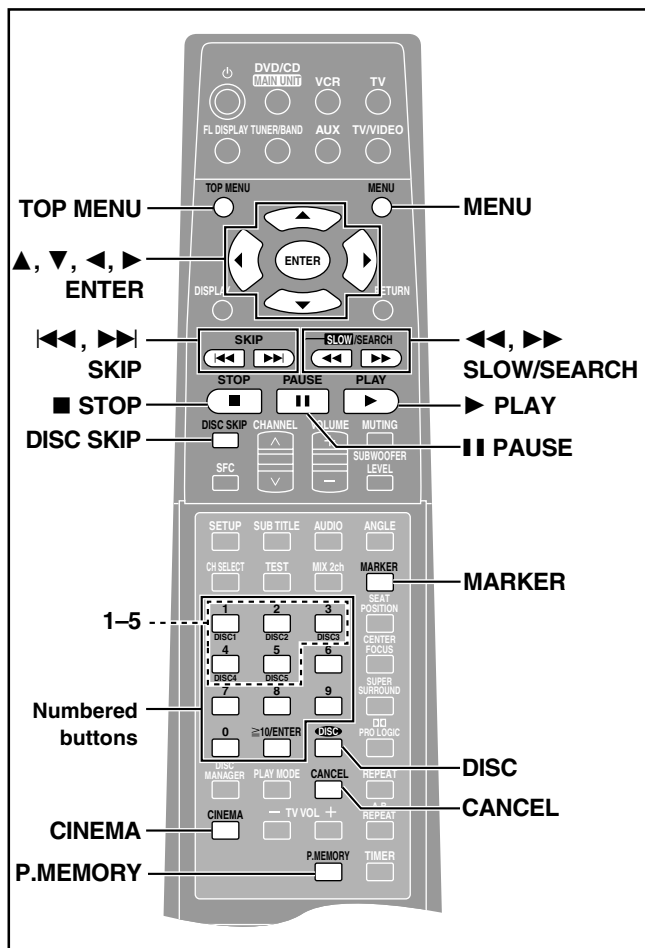

To show other pages

Press [▲, ▼, ◀, ▶] to select “Prev” or “Next” and press [ENTER]. After listing all the tracks in one group, the list for the next group appears.

To close the file list screen

Press [TOP MENU] or [MENU].

Using the tree screen to find a group

1 Press [▶] while a track is highlighted to display the tree screen.

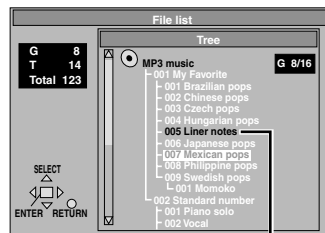

You cannot select groups that contain no compatible files.

2 Press [▲, ▼] to select a group and press [ENTER].

The file list for the group appears.

For your reference

- Press [◀, ▶] to jump layers in the tree screen.

Refer to the glossary on page 32 for more information about MP3.

Resume function

DVD-V | CD | VCD

(When the elapsed play time is displayed)

“RESUME” lights on the display when the unit has recorded the position at which you stopped play. Press [▶] (PLAY) to start play from that position. (When playing DVD-Video ⇒ Chapter Preview below)

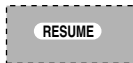

- The position is cleared when:
 - The unit is turned off.
 - The disc is changed or removed.
 - A source other than DVD/CD is selected.
- Press [■] to clear the position.

Position Memory function

During play

Press [P.MEMORY] to memorize a position.

The message “Position memorized” appears on the television. This position is saved even if you change or remove the disc, change the source, or turn the unit off.

When you reselect or reinsert the disc, reselect DVD/CD, or turn the unit on, “RESUME” lights on the display.

Press [▶] (PLAY) to start play from the memorized position.

The position is cleared.

(When playing DVD ⇒ Chapter Preview below)

To clear the position before play

Press [■].

- You can memorize positions on up to five different discs at a time. When you memorize another position, the earliest position is replaced.

Chapter Preview DVD-V

The message “Press PLAY to Preview Chapters” appears immediately after you press [▶] (PLAY).

Press [▶] (PLAY) while the message is displayed and the beginning portions of each chapter up to the current one are played. Full play resumes from the point where you pressed [■] or [P.MEMORY].

(This feature works only within a title.) If you do not press [▶] (PLAY), the message disappears and play starts from where you pressed [■] or [P.MEMORY].

Using menus to play MP3 discs

CD (MP3 discs)

This unit can play MP3 files recorded on CD-R/RW with a computer. Files are treated as tracks and folders are treated as groups.

Naming folders and files

At the time of recording, prefix folder and file names with 3-digit numbers in the order you want to play them (this may not work at times).

Example: MP3

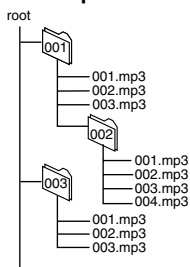

1 Press [TOP MENU] or [MENU].

A file list appears.

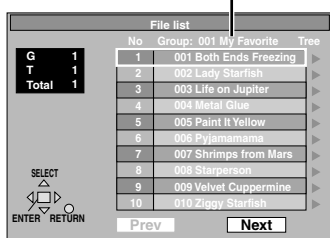

2 Press [▲, ▼] to select the track and press [ENTER].

Play starts and continues to the last track in the last group.

“▶” indicates the track currently playing.

Skipping chapters or tracks

DVD-V CD VCD

Press [**◀◀**] or [**▶▶**].

- Each press increases the number of skips.
- Press [**◀◀/◀◀, ▶▶/▶▶**] on the main unit.

Fast forward and rewind—SEARCH

DVD-V CD VCD

During play

Press [**◀◀**] or [**▶▶**].

- Press and hold [**◀◀/◀◀, ▶▶/▶▶**] on the main unit.

- Audio will be heard during search. You can turn this audio off if you want to (⇒ page 24, Audio—Audio during Search).

Slow-motion play

DVD-V VCD

While paused

Press [**◀◀**] or [**▶▶**].

- Press and hold [**◀◀/◀◀, ▶▶/▶▶**] on the main unit.

Frame-by-frame viewing

DVD-V VCD

Remote control only

While paused

Press [**◀**] or [**▶**].

The frame changes each time you press the button.

- The frames change in succession if you press and hold the button.
- Pressing [**⏮**] also activates forward frame-by-frame.

Note

- The speed of search and slow-motion increases up to 5 steps.
- Press [**▶**] (PLAY) to restart play.
- You cannot move backwards with Video CD during frame-by-frame and slow-motion.

When playing Video CDs with playback control

Pressing buttons to perform skip, search or slow-motion may take you to a menu screen.

Starting play from a selected track

CD VCD

Remote control only

1 Press [DISC].

2 Press [1]–[5] to select a disc.

3 Wait for the disc to change and play to start

Press the numbered buttons to select the track.

To select a 2-digit number

Example: To select track 23, press [≥ 10 /ENTER] ⇒ [2] ⇒ [3].

Play starts from the selected item.

Note

- This works only when stopped with some discs.
- **MP3 discs**
Press [ENTER] after pressing the numbered buttons. (You do not have to press [≥ 10 /ENTER].)

Disc skip

DVD-V CD VCD

Press [DISC SKIP].

Play starts from the beginning of the disc in the next tray. You will skip to tray 1 when the current tray is 5.

Note

[DISC SKIP] does not work during program and random play or while the disc manager is on.

Cinema

DVD-V VCD

Remote control only

You can change the picture quality for movie viewing.

Press [CINEMA].



Each time you press the button:

- **Cin.1:** Mellow images and enhances detail in dark scenes.
- ↓
- **Cin.2:** Sharpens images and enhances detail in dark scenes.
- ↓
- **Nor.:** Normal mode (Factory preset)

For your reference

You can make finer adjustments to the picture if desired (⇒ page 17, Digital picture mode—User mode).

Marking places to play again—MARKER

DVD-V CD VCD

(When the elapsed play time is displayed)

Remote control only

You can mark up to 5 points on a disc to return to later.

1

During play

Press [MARKER].

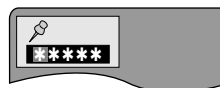

2

Press [ENTER] at the point you want to mark.

To select another marker, press [**◀**, **▶**].

To play from a marked position

Press [**◀**, **▶**] to select a marker number and press [ENTER].

To clear a marker

Press [**◀**, **▶**] to select a marker number and press [CANCEL].

Note

- Some subtitles may fail to appear around the marker.
- All the markers are cleared when:
 - The unit is turned off.
 - The disc is changed or removed.
 - A source other than DVD/CD is selected.

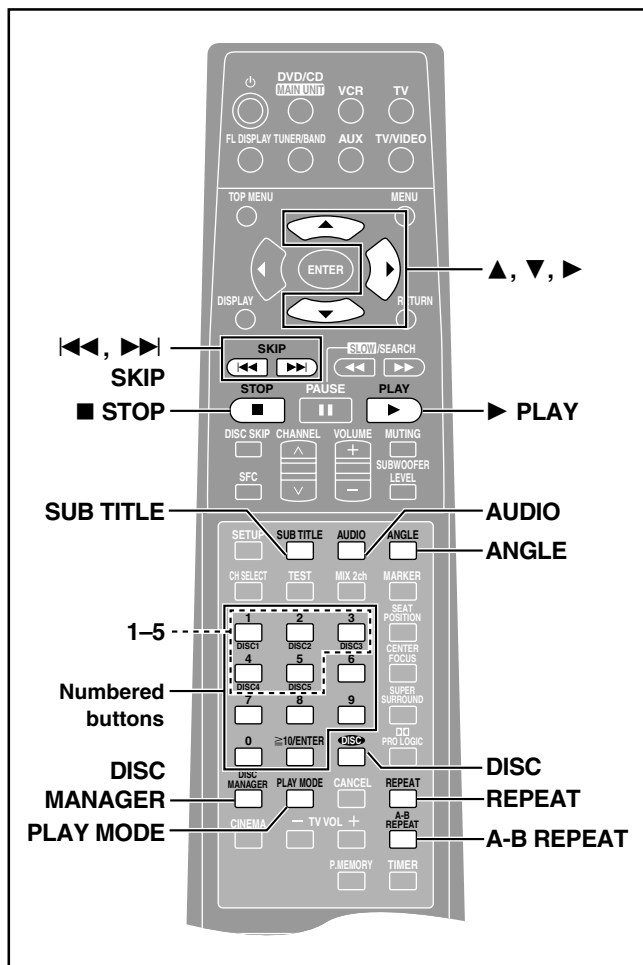

Repeat play

During play

Press **[REPEAT]**.

Each time you press the button:

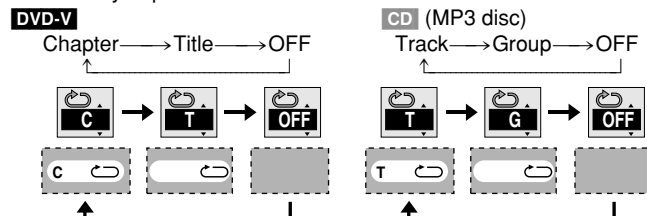

CD VCD
Repeat on ↔ OFF

You can repeat tracks as follows depending on the DISC MANAGER setting (⇒ page 15).

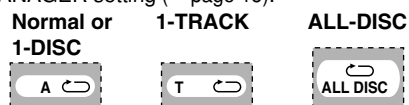

If the Video CD has playback control

1. Press **[■]**.
2. Press the numbered buttons to select a track to start play (⇒ page 13).
3. Press **[REPEAT]** (⇒ above).

Note

You cannot use repeat play to repeat an entire DVD-Video or an entire MP3 disc.

To repeat only your favorite tracks

CD VCD

Start program play (⇒ page 15) and press **[REPEAT]** to display the repeat mode you like.

Remote control only

A-B repeat play/Repeat play

DVD-V (When the elapsed play time is displayed)

CD VCD

A-B repeat play

You can repeat a section between points A and B within a title or track.

- 1 During play
Press **[A-B REPEAT]** at the starting point (A).



- 2 Press **[A-B REPEAT]** at the finishing point (B).



A-B repeat starts.

To cancel

Press **[A-B REPEAT]** until “” is displayed.

Note

- Some subtitles recorded around point A or B may fail to appear.
- The unit automatically determines the end of a title/track as point B when the end of the title/track is reached.

Subtitles/Soundtracks/Angles

DVD-V

Some DVDs have multiple soundtracks, subtitle languages and camera angles, and you can change these during play.

- “—” or “_” is displayed instead of the language number in circumstances such as when no language is recorded on the disc.

Subtitles

During play

Press **[SUB TITLE]**.

The number changes each time you press the button.

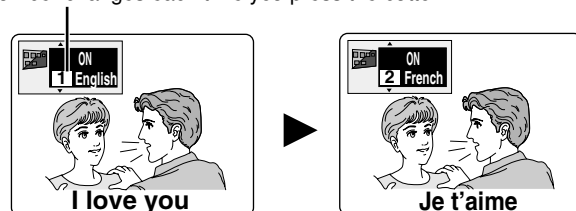

- In some cases, the subtitle language is not changed to the selected one immediately.
- If the subtitles overlap closed captions recorded on discs, turn the subtitles off.

To clear/display the subtitles

1. Press **[SUB TITLE]**.
2. Press **[▶]**.
3. Press **[▲, ▼]** to select “OFF” or “ON”.

Soundtracks

During play

Press [AUDIO].

The number changes each time you press the button.



- You can also use this button to turn the vocals on and off on karaoke discs. Read the disc's instructions for details.
- Refer to **B** on page 17 for audio signal type details.

VCD

Audio changes as follows each time you press [AUDIO]:

LR→L→R
↑

This may not work with some discs.

Angles

"ANGLE" lights on the unit's display when this is available.

During play

Press [ANGLE].

The number changes each time you press the button.

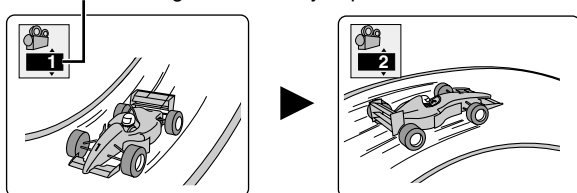

Using the disc manager

CD VCD

The disc manager allows you to choose one track or disc to play or to play all five discs in succession.

1 While stopped

Press [DISC MANAGER] to select the desired method.

Each time you press the button:

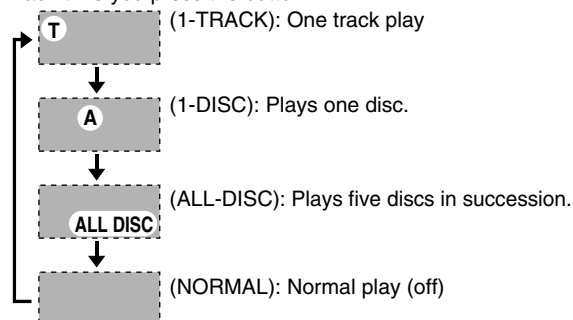

2 Select the disc and track.

- When selecting "1-DISC", press [DISC] and [1]–[5].
 - When selecting "1-TRACK", press the numbered buttons.
- To select a 2-digit number**
Example: To select track 23: press [≥ 10 /ENTER] → [2] → [3].
You can also select the track by pressing [◀◀] and [▶▶].

3 Press [▶] (PLAY).

To cancel disc manager

Press [■].

To play a track or disc repeatedly

Press [REPEAT] during disc manager play.

Note

- You cannot use the disc manager while "RANDOM" or "PRGM" are on.
- When playing video CDs with playback control in the "A" or "ALL DISC" mode, you can play the disc without having to operate the disc's menus.
- The disc manager skips any DVD and MP3 discs that are loaded.

Program play/Random play

CD VCD

While stopped

Press [PLAY MODE] to select the play mode.

The mode changes as follows each time you press the button.

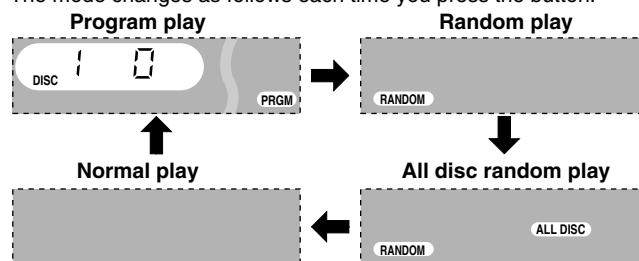

After selecting the mode, follow the steps for the mode.

Program play

To play a maximum of 24 tracks in a programmed order
Select tracks from any disc.

- 1 Press [DISC] and [1]–[5] to select the disc.
- 2 Press the numbered buttons to select a track.
 - Repeat steps 1 and 2 to program other tracks.
 - Step 1 is unnecessary when programming tracks on the same disc.
- 3 Press [▶] (PLAY).
Play now begins in the programmed sequence.

When play is stopped and the program contents are shown on the display, you can also do the following.

- **To add tracks**
Repeat steps 1 and 2.
- **To check program contents**
Press [◀◀] or [▶▶].
- **To clear tracks**
Press [CANCEL] to clear the last track in the program, or press [◀◀] or [▶▶] to select a track and press [CANCEL].
- **To clear the whole program**
Press [■] so "CLEAR" is displayed. (If "CLEAR" is not displayed, start and stop play, then press [■] again.)

Note

Discs or tracks the unit cannot find can be programmed but are canceled during play. This is also the case if you program DVD-Video and MP3 discs.

Random play

To play tracks on the current disc randomly

Press [▶] (PLAY).

Play now begins in random order.

All disc random play

To play tracks on all discs randomly

Press [▶] (PLAY).

Play now begins in random order.

- DVD and MP3 discs are skipped during all disc random play.

Normal play

The program or random mode is canceled (normal play mode is restored) when:

- The unit is turned off.
 - The disc is changed or removed.
 - A source other than DVD/CD is selected.
- The program is retained in memory.

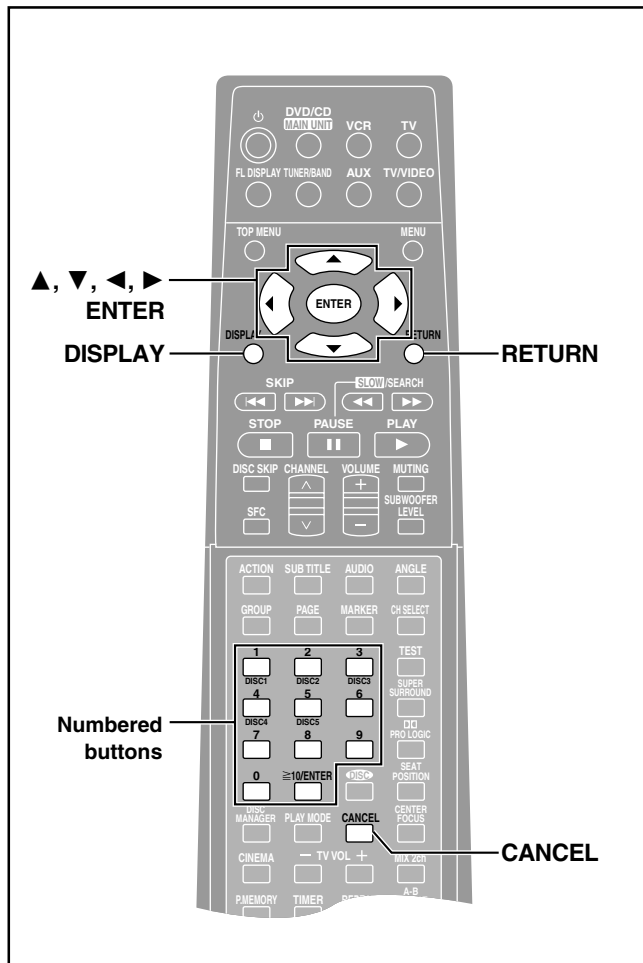

DVD-V

Remote control only

On-Screen Menu Icons are menus that contain information about the disc or unit. These menus allow you to perform operations by changing this information.

Common procedures

1 Press [DISPLAY].

Each time you press the button:

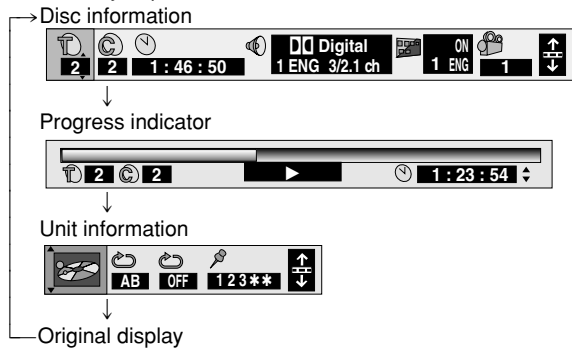

- The screens depend on disc contents.

2

Unit information only

While the leftmost icon is highlighted

Press [▲, ▼] to select the menu.

Each time you press the button:

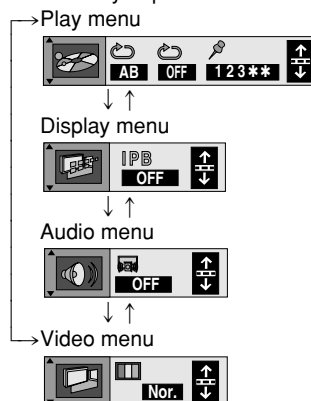

3

Press [◀, ▶] to select the item.

4

Press [▲, ▼] to select the setting.

- Items with “▲” or “▼” above and below can be changed by [▲, ▼].
- Press [ENTER] if the setting does not change after pressing [▲, ▼].
- Some items require different operations. Read the explanations on the following pages.

For your reference

- Depending on the condition of the unit (playing, stopped, etc.) and the type of software you are playing, there are some items that you cannot select or change.
- When numbers are displayed (e.g. title No.), the numbered buttons are also effective for setting. After entering the numbers, press [ENTER] to register the setting.

To clear the menus

Press [RETURN] until the menus disappear.

■ To change the position of the menus

1. Press [◀, ▶] to select the rightmost icon.
2. Press [▲, ▼] to move the menus.



(There are 5 positions.)

Progress indicator

Indicates how far you have played through an item.

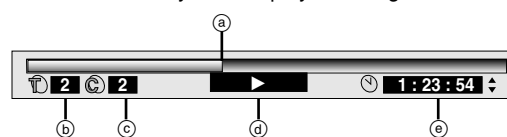

- (a) Current position
- (b) Title number
- (c) Chapter number
- (d) Condition – play, pause, or slow/search
- (e) Time (When the elapsed play time is displayed)
 - Press [▲, ▼] to show the elapsed play time or remaining time for the title.
 - Select a position to start play by specifying a time with the numbered buttons.

Disc information



Icon	Content
	Title number
	Chapter number
	Time • Press [▲, ▼] to show the elapsed play time or remaining time for the title. • Select a position to start play by specifying a time with the numbered buttons.
	Soundtrack (a) Soundtrack language (See A below for language abbreviations.) (b) Audio signal type (See B below for details.)
	Karaoke vocal on/off (Karaoke DVD only) Solo: OFF or ON Duet: OFF, V1+V2, V1 or V2
	Subtitle language (See A below for language abbreviations.)
	Subtitles on/off ON ↔ OFF
	Angle number

A Audio/Subtitle language

ENG: English	SVE: Swedish	CHI: Chinese
FRA: French	NOR: Norwegian	KOR: Korean
DEU: German	DAN: Danish	MAL: Malay
ITA: Italian	POR: Portuguese	VIE: Vietnamese
ESP: Spanish	RUS: Russian	THA: Thai
NLD: Dutch	JPN: Japanese	*: Others

B Signal type/data

LPCM/Digital: Signal type
 k (kHz): Sampling frequency
 b (bit): Number of bits
 ch (channel): Number of channels
 Example:
 3/2 .1ch

.1: Subwoofer signal (not displayed if there is no subwoofer signal)
0: No surround 1: Mono surround 2: Stereo surround (left/right)
1: Center 2: Front left+Front right 3: Front left+Front right+Center

Unit information

Play menu

Icon	Content
	A-B repeat (⇒ page 14) [ENTER] (start point) ⇒ [ENTER] (finish point) To cancel: [ENTER]
	Repeat play (⇒ page 14) Chapter (C) ↔ Title (T) ↔ OFF ↑
	Marker (⇒ page 13) You can mark up to 5 positions to play again. [ENTER] (The unit is now ready to accept markers.) To mark a position [ENTER] (at the desired point) To mark another position: [◀, ▶] ⇒ [ENTER] To recall a marker: [◀, ▶] ⇒ [ENTER] To erase a marker: [◀, ▶] ⇒ [CANCEL]

Display menu

	I/P/B display (⇒ page 32) ON ↔ OFF Displays the picture type (I/P/B) in the still picture mode.
--	--

Audio menu

	(Dolby Digital, 3-channel or over only) Dialogue Enhancer ON ↔ OFF The volume of the dialogue from the center channel is raised when you select "ON".
--	---

Video menu

	Digital picture mode Nor.: Normal mode Cin.1/Cin.2: Cinema mode (⇒ page 13) User: User mode The following items are also displayed when you select "User".
	Contrast (-7 to +7) Increases the contrast between white and black parts of the picture.
	Brightness (0 to +15) Brightens the picture.
	Color (-7 to +7) Adjust the shade of the picture's color.

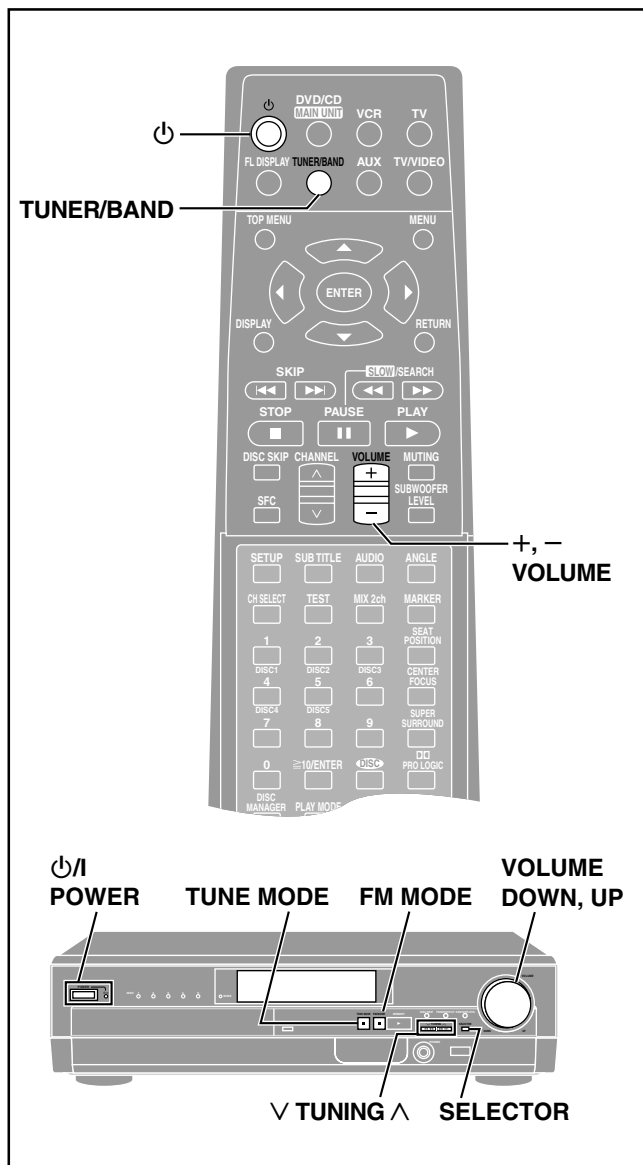

Radio stations can be tuned manually by selecting the station's frequency or they can be preset into channels to make it easy to tune (➔ page 19).

Preparation

Press [POWER] to turn on the unit.

1 Press [SELECTOR] to select "FM" or "AM".

Each time you press the button:
DVD/CD → FM → AM → TV → VCR → AUX

• Remote control: Press [TUNER/BAND].



2 Press [TUNE MODE] to select "MANUAL".

Each time you press the button:
MANUAL ↔ PRESET



3 Press [TUNING (V or ^)] to select the frequency of the required station.

Displayed when a stereo FM broadcast is being received.

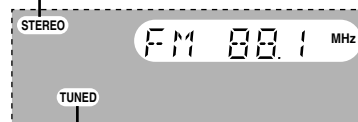

Displayed when a radio station is tuned.

Press and hold [TUNING (V or ^)] until the frequency starts scrolling to start automatic tuning. Tuning stops when a station is found.

4 Adjust the volume.

If noise is excessive in FM

Press [FM MODE] to display "MONO".

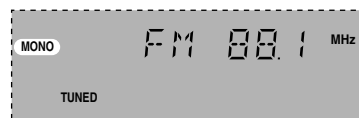

This mode improves sound quality if reception is weak but broadcasts are heard in monaural.

Press [FM MODE] again to cancel the mode.

The mode is also canceled when you changed the frequency.

Turn "MONO" off for normal listening.

Stereo and monaural broadcasts are automatically played as they are received.

FM frequency step

The step is factory-set to 0.2 MHz, but you can change it to receive broadcasts allocated 0.1-MHz steps.

① Press [SELECTOR] to select "FM".

② Press and hold [SELECTOR].

After a few seconds the display changes to show the current minimum frequency. Continue to hold the button down. The minimum frequency changes and the step is changed.

To return to the original step, repeat the above steps.

Note

Any FM frequencies preset in channels will be changed by this procedure. Preset them again.

Manual presetting

Main unit only

Preset the stations one at a time.

- 1 Tune to the station (⇒ page 18).
- 2 Press [MEMORY] twice.
- 3 Press [TUNING (∨ or ∧)] to select a channel.
- 4 Press [MEMORY].

The station occupying a channel is erased if another station is preset in that channel.

Selecting channels

- 1 Press [TUNER/BAND] to select “FM” or “AM”.

•Main unit: Press [SELECTOR].
Each time you press the button:
DVD/CD → FM → AM → TV → VCR → AUX



- 2 Press the numbered buttons or [CHANNEL (∧ or ∨)] to select the channel.

To select a 2-digit number

Example: To select channel 12, press [≥10/ENTER] ⇒ [1] ⇒ [2].

•Main unit: Press [TUNING (∨ or ∧)] while “PRESET” is selected.

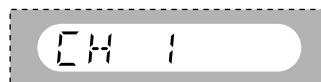

- 3 Adjust the volume.

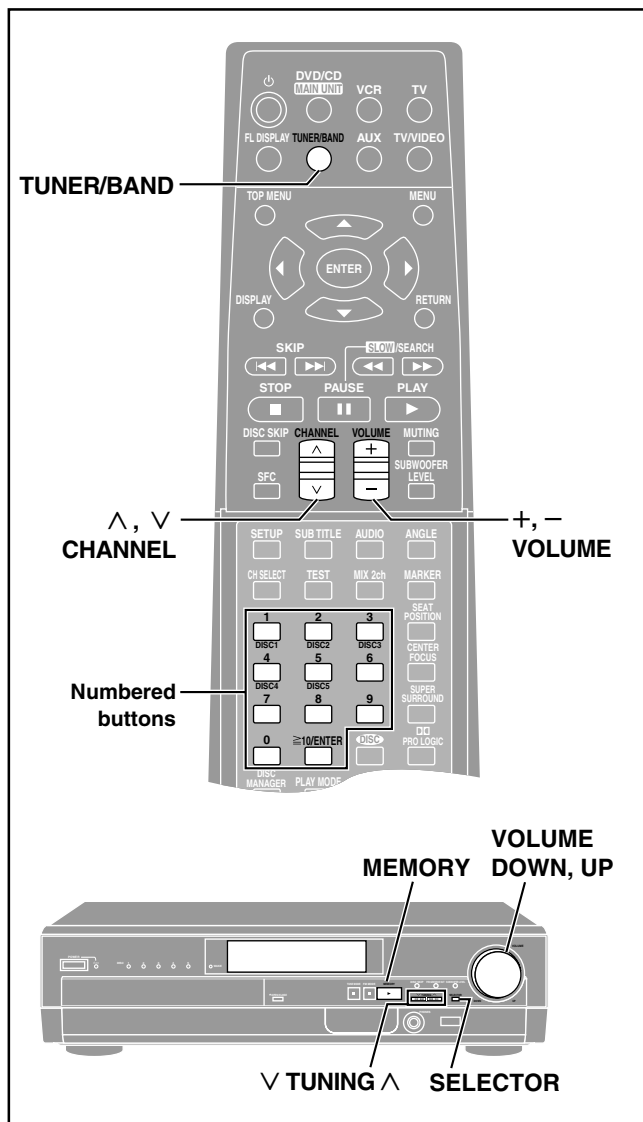

There are two methods of presetting stations.

Automatic presetting: The stations the tuner can receive are preset.

Manual presetting: You can select the stations to preset and the order they are preset in.

Up to 12 stations can each be set in the FM and AM bands.

Automatic presetting

Main unit only

- 1 Tune to “FM 87.9 MHz” (⇒ page 18).

- 2 Press and hold [MEMORY].

The FM stations the unit can receive are preset.



- 3 Tune to “AM 520 kHz” (⇒ page 18).

- 4 Press and hold [MEMORY].



The AM stations the unit can receive are preset.



The last station to be preset is displayed when presetting finishes.

Note

- Dolby Pro Logic and Super Surround cannot be used if headphones are connected.
- You may experience a reduction in sound quality when these sound field systems and effects are used with some sources. If this occurs, turn the surround system or effect off.

Sound field system	Features	Software	Other effects	
DOLBY DIGITAL (→ page 21)	<ul style="list-style-type: none"> •Dolby Digital is a digital encoding system used on DVD to carry surround sound. It was originally developed for use in cinemas. •This unit automatically recognizes and decodes Dolby Digital. 	<p>Software encoded with Dolby Digital can be identified with this mark.</p>  <ul style="list-style-type: none"> •DVD 	Seat position Center focus	
DOLBY PRO LOGIC (→ page 21)	<p>Dolby Pro Logic is a decoding system that was developed to get a better sense of presence from sources encoded with Dolby Surround. The feeling of position has been improved by the addition of a separate center speaker channel.</p>	<p>Software encoded with Dolby Surround can be identified with this mark.</p>  <ul style="list-style-type: none"> •DVD •CD, Video CD •Laser Disc •Video tape •Radio 	Seat position Center focus	
SUPER SURROUND (→ page 22)	MUSIC	<ul style="list-style-type: none"> •This mode adds surround effects to stereo sources. •You can adjust the volume of the surround speakers to get the best surround effect. 	Any stereo sound source.	—
	MOVIE	<ul style="list-style-type: none"> •This mode adds surround effects to movie software that hasn't been recorded with the above systems. •You can adjust the volume of the surround speakers to get the best surround effect. 	Any source.	Seat position
SFC (Sound Field Control) (→ page 21)	Use SFC effects to change the sound quality and add reverberation.	Any source.	—	

Sound quality/sound field operations

Seat position (→ page 22)

•This mode helps maintain the sound position even if the listening position itself is changed.

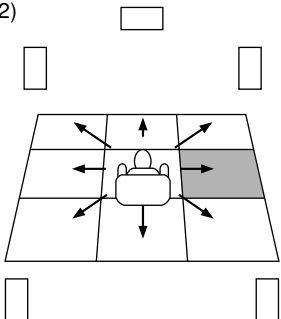

Center focus (→ page 22)

•This mode makes it seem like the sound from the center speaker is coming from within the television.

You can select one of two levels.

•The center speaker should be placed above the television.

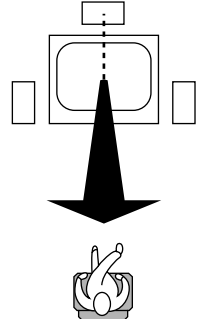

DOLBY PRO LOGIC

1 Press [DOLBY PRO LOGIC].



2 Play a Dolby Surround source.

To cancel

Press [DOLBY PRO LOGIC].

Note

Turn Dolby Pro Logic off when playing a DVD recorded with Dolby Digital. The surround effects will not be reproduced correctly if this is left on.

Speaker level adjustments

If the level of the speakers appears to be different while listening to a source, adjust the level of the speakers to the same apparent level.

Preparation

DOLBY DIGITAL: Turn off the other sound field systems.

DOLBY PRO LOGIC: Press [DOLBY PRO LOGIC].

- Press [TEST] to output a test signal.



Lch: Front left (-16 dB to 0 dB)

Cch: Center (+6 dB to -10 dB)

Rch: Front right (-16 dB to 0 dB)

RSch: Right surround (+6 dB to -10 dB)

LSch: Left surround (+6 dB to -10 dB)

•The surround channel for Dolby Pro Logic is monaural so the indicator appears as "Sch" instead.

- Press [▲] (to increase) or [▼] (to decrease).

To stop the test signal, press [TEST] again.

To adjust speaker level during play

- Press [CH SELECT] to select the speaker.

Lch→Cch→Rch→RSch→LSch→SWch

↑

SWch: Subwoofer (+10 dB to -10 dB)

Dolby Pro Logic

•The surround channel is monaural so the indicator appears as "Sch" instead.

•"SWch" does not appear.

- Press [▲] (to increase) or [▼] (to decrease).

Changing sound field and quality

Press [SFC] to select a setting.



Each time you press the button:

HEAVY: Adds punch to rock (factory preset).

CLEAR: Clarifies higher sounds.

SOFT: For background music.

DISCO: Reverberates sound to make you feel like you were in a disco.

LIVE: Makes vocals more alive.

HALL: Expands sound to make you feel like you were in a hall.

FLAT: Canceled (no effect is added).

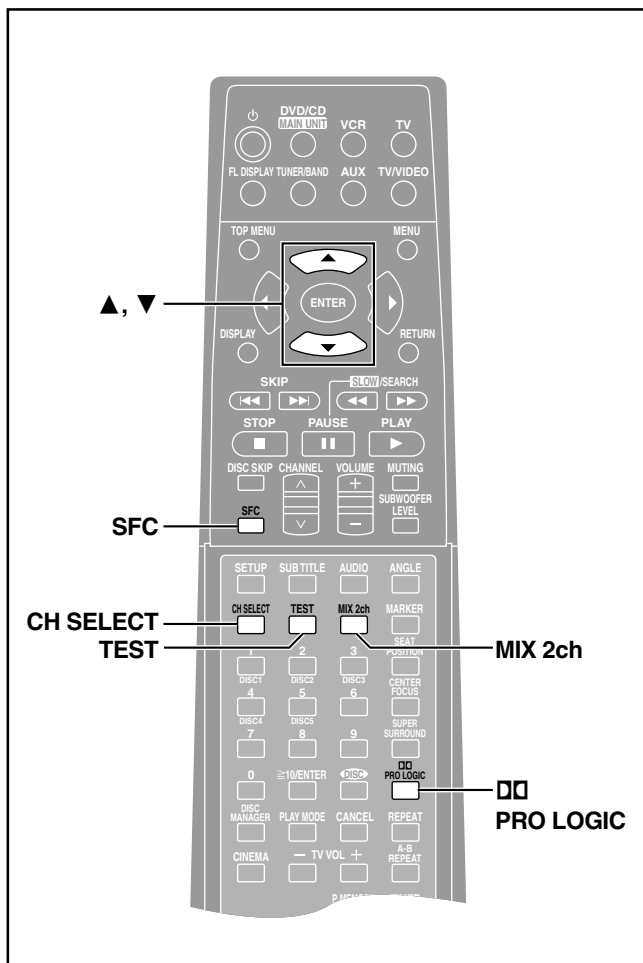

Remote control only

DOLBY DIGITAL

Play a DOLBY DIGITAL source.

"DOLBY DIGITAL" lights.

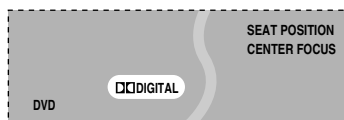

To add power to the bass from the subwoofer → page 22.

To down-mix Dolby Digital (5.1 ch) signals to 2 channels (Front L/R)

Press [MIX 2ch] during play.

To cancel, press [MIX 2ch] again.



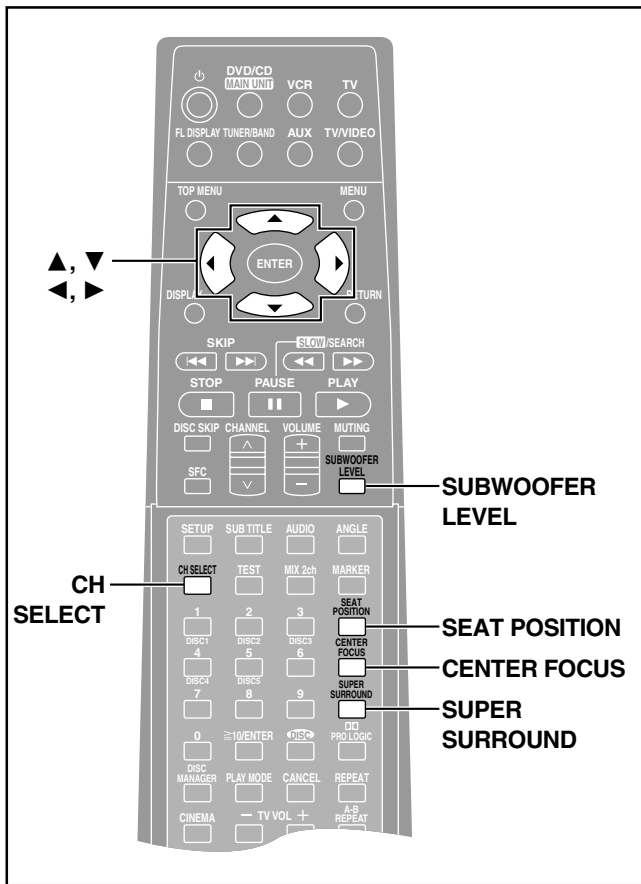

SEAT POSITION

Using this function makes you feel like you are sitting in the ideal seating position (in the center of the circle formed by the speakers), even if you cannot due to the layout of your room.

1 Press [SEAT POSITION].

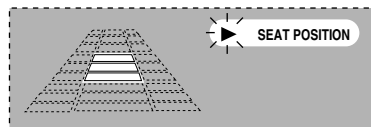

2 While "▶" is flashing Press [▲, ▼, ◀, ▶] to select a position.

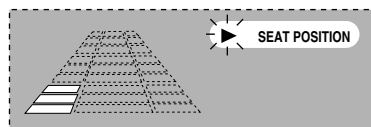

To cancel
Press [SEAT POSITION] to clear "▶".

CENTER FOCUS

You can make the sound of the center speaker seem like it is coming from within the television. Place the center speaker above the television.

Press [CENTER FOCUS].



Each time you press the button:
CENTER FOCUS 1 → CENTER FOCUS 2 → OFF

The CENTER FOCUS 2 enhances the effect and makes it easier to hear dialogue even at low volume.

To cancel
Press [CENTER FOCUS] to clear "▶".

Adjusting the bass

Press [SUBWOOFER LEVEL].

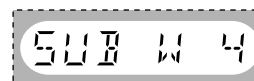

Each time you press the button:
SUB W 1 → SUB W 2 → SUB W 3 → SUB W 4 → SUB W 0 (off)

Note
You cannot adjust the bass while you are using headphones ("ERROR" appears on the display).

Remote control only

SUPER SURROUND

Press [SUPER SURROUND] to select "MUSIC" or "MOVIE".

Each time you press the button:

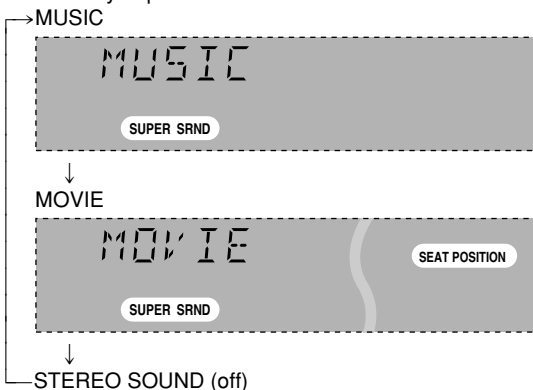

To cancel
Press [SUPER SURROUND] to select "STEREO SOUND".

Note
Turn super surround off when playing a DVD recorded with Dolby Digital. The surround effects will not be reproduced correctly if this is left on.

To adjust the surround speaker level

While playing a source

- ① Press [CH SELECT].
- ② Press [▲] (to increase) or [▼] (to decrease).

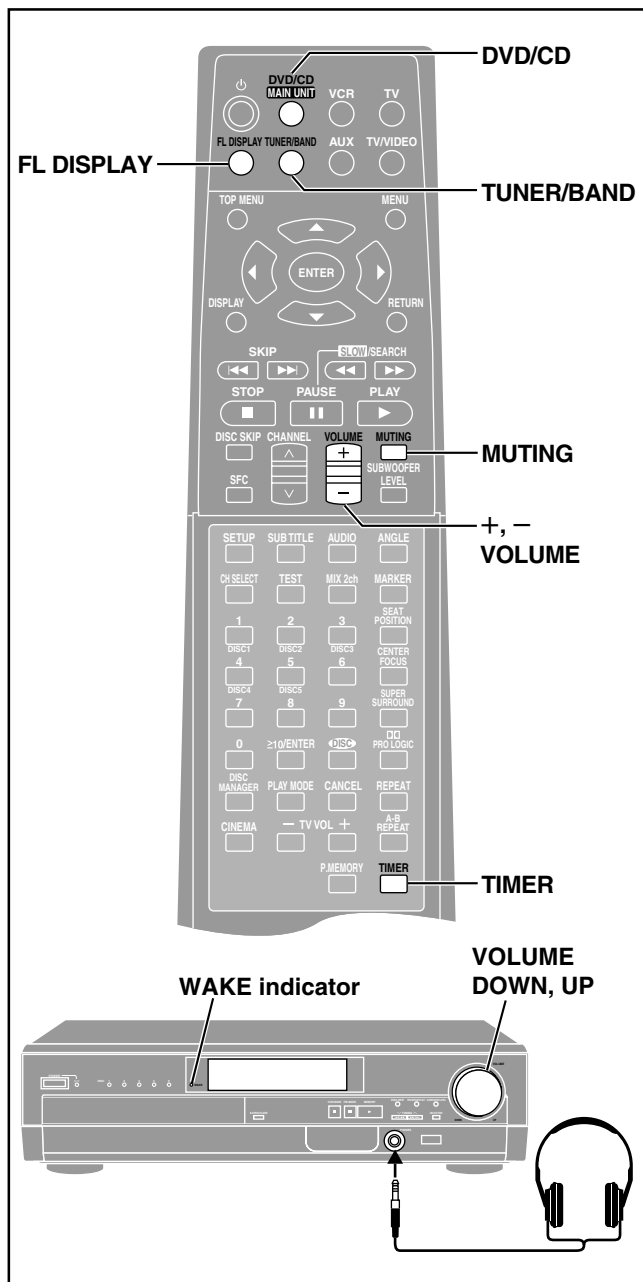

Muting the volume

Remote control only

Press [MUTING].



Volume is reduced to minimum.

To cancel

Press [MUTING] again or reduce the volume to minimum (--- dB), then raise it to the required level.

Muting is also canceled when the unit is turned off.

Turning off the display

Remote control only

The display and all indicators, except for the standby/on indicator, are turned off for better television viewing.

Press [FL DISPLAY].

To cancel, press [FL DISPLAY] again.

Timer functions

Remote control only

The SLEEP timer can turn the unit off after a set time and the WAKE timer can turn it on. You can use only one timer at a time.

Preparation

Select the desired source.

•Disc

Press [DVD/CD] to display "DVD/CD", and insert an Audio CD, etc.

•The radio

Press [TUNER/BAND] to select "FM" or "AM" and tune in the desired station.

1 Press [TIMER] to select the timer.

Each time you press the button:

SLEEP → WAKE → OFF

2 Within 5 seconds,

Press and hold [TIMER] and release when the timer you require is displayed.

The display changes as follows:

•SLEEP (in minutes)

30 → 60 → 90

•WAKE (in hours)

5H → 7H → 9H

•SLEEP starts working immediately.

•WAKE starts working when you switch the unit to standby.

(The "WAKE" indicator lights up.)

To cancel the timer

Press [TIMER] to select "OFF".

To check the setting

Press [TIMER] once.

•If you set SLEEP, the time remaining appears.

•If you set WAKE, the setting appears.

To change the setting

Repeat the procedure from the beginning.

Using headphones

1 Reduce the volume and connect the headphones (not included).

Headphone plug type: 6.3 mm (1/4") stereo

2 Adjust headphone volume with [VOLUME].

Audio is automatically switched to stereo (2-channel). If sound is distorted, turn on dynamic range compression (➡ page 24, Audio—D. Range Compression).





Note

Avoid listening for prolonged periods of time to prevent hearing damage.

Changing settings

This chart shows the settings for this unit. Change the settings to suit your preferences and to suit the unit to the environment in which it is being used. These settings are retained in memory until they are changed, even if the unit is turned off. See page 25 for details on menu operation.

● Underlined items are the factory preset.

Menus	Items	Options
Disc DVD-V 	Audio Choose the preferred audio language.	<u>English</u> French Spanish Original Other **** Original: The original language of each disc will be selected. Other ****: Input a code number with the numbered buttons (⇒ page 32).
	Subtitle Choose the preferred subtitle language.	<u>Automatic</u> English French Spanish Other **** Automatic: If the language selected for “Audio” is not available, subtitles of that language will automatically appear if available on that disc.
	Menus Choose the preferred language for disc menus.	<u>English</u> French Spanish Other ****
	Ratings (⇒ page 25) Set a ratings level to limit DVD-Video play. ● The password screen is shown if you choose levels 0 to 7 or if you choose “Ratings” when levels 0 to 7 have been selected. ● Select “Level 0” to prevent play of discs that do not have ratings levels recorded on them.	Setting ratings (When level 8 is selected) 8 No Limit : All DVD-Video can be played. 1 to 7 : Prohibits play of DVD-Video with corresponding ratings recorded on them. 0 Lock All : Prohibits play of all DVD-Video. <hr/> Changing ratings (When level 0–7 is selected) Unlock Player Change Level Change Password Temporary Unlock
Video 	TV Aspect (⇒ page 9) Choose the setting to suit your television and preference.	<u>4:3 Pan&Scan</u> 4:3 Letterbox 16:9
	Still Mode (⇒ page 32) Specify the type of picture shown when paused.	<u>Automatic</u> Field Frame
	Black Level Control Change the black level of the picture.	<u>Lighter</u> Darker
Audio 	Speaker Setting DVD-V (⇒ page 25) (Dolby Digital only) Set the delay time for your center and surround speakers.	Center: 0/1.3/2.6/3.9/5.3 ms Surround (L/R): 0/5.3/10.6/15.9 ms
	D. Range Compression DVD-V (Dolby Digital only) Change the dynamic range for late night viewing.	<u>Off</u> On Turn dynamic range compression on in the following cases. ● For clear dialogue when listening at low volume. ● When sound is distorted while playing multi-channel DVD through two channels (when headphones are connected or when using the MIX 2ch mode.)
	Audio during Search Choose whether to have sound during search.	<u>On</u> Off
Display 	Menu Language Choose the preferred language for these menus and the on-screen messages.	<u>English</u> Français Español
	On-Screen Messages Choose whether to show on-screen messages or not.	<u>On</u> Off
Others 	QUICK SETUP Answer questions to make basic settings.	Yes <u>No</u>

Entering a password (Ratings)

DVD-V

The password screen is shown when you select levels 0 to 7.

- Input a 4-digit password with the numbered buttons and press [ENTER].
 - If you enter a wrong number, press [CANCEL] to erase it before you press [ENTER].
 - The lock symbol appears closed to show the rating is locked.
 - Do not forget your password.**
- Press [ENTER] to confirm the 4 digits.

Now, when you insert a DVD-Video that exceeds the ratings limit you set, a message appears on the television. Follow the on-screen instructions.

Changing the delay time

DVD-V (Dolby Digital, center and surround speakers only)

For optimum listening with 5.1-channel sound, all the speakers, except for the subwoofer, should be the same distance from the seating position. If you have to place the center or surround speakers closer to the seating position, adjust the delay time to make up for the difference.

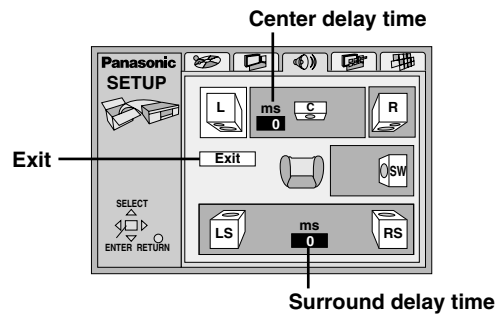

Changing the delay time

- Press [\blacktriangle , \blacktriangledown , \blacktriangleleft] to select the delay time box and press [ENTER].
- Press [\blacktriangle , \blacktriangledown] to adjust the delay time and press [ENTER].

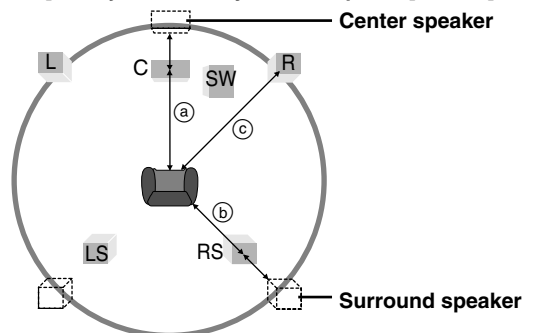

Values

If distance (a) or (b) is greater than or equal to distance (c), set to "0". If distance (a) or (b) is less than distance (c), set as follows.

(a) Center speaker

Difference	Setting
Approx. 50 cm (1½ feet)	1.3 ms
Approx. 100 cm (3 feet)	2.6 ms
Approx. 150 cm (5 feet)	3.9 ms
Approx. 200 cm (6 feet)	5.3 ms

(b) Surround speakers

Difference	Setting
Approx. 200 cm (6 feet)	5.3 ms
Approx. 400 cm (12 feet)	10.6 ms
Approx. 600 cm (18 feet)	15.9 ms

When you are finished

Press [\blacktriangleleft] to select "Exit" and press [ENTER].

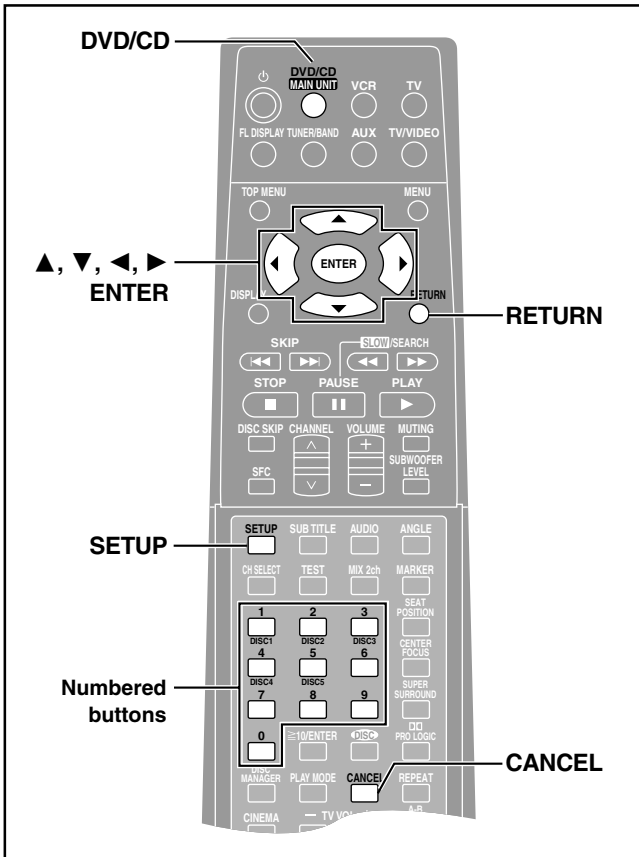

Common procedures

Remote control only

See page 24 for menu and option details.

Preparation

Press [DVD/CD] to select "DVD/CD".

1 Press [SETUP] to show the menus.

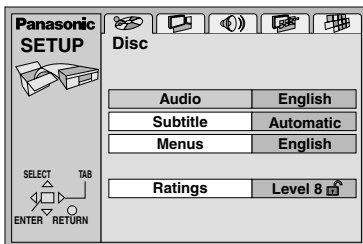

- The QUICK SETUP screen appears when you press [SETUP] the first time after purchase (→ page 9).

2 Press [\blacktriangleleft , \blacktriangleright] to select the menu's tab.

The screen changes to display the menu.



3 Press [\blacktriangle , \blacktriangledown] to select the item you want to change and press [ENTER].

4 Press [\blacktriangle , \blacktriangledown] to select the option and press [ENTER].

The screen now shows the menu again.

To return to the previous screen

Press [RETURN].

When you are finished

Press [SETUP].

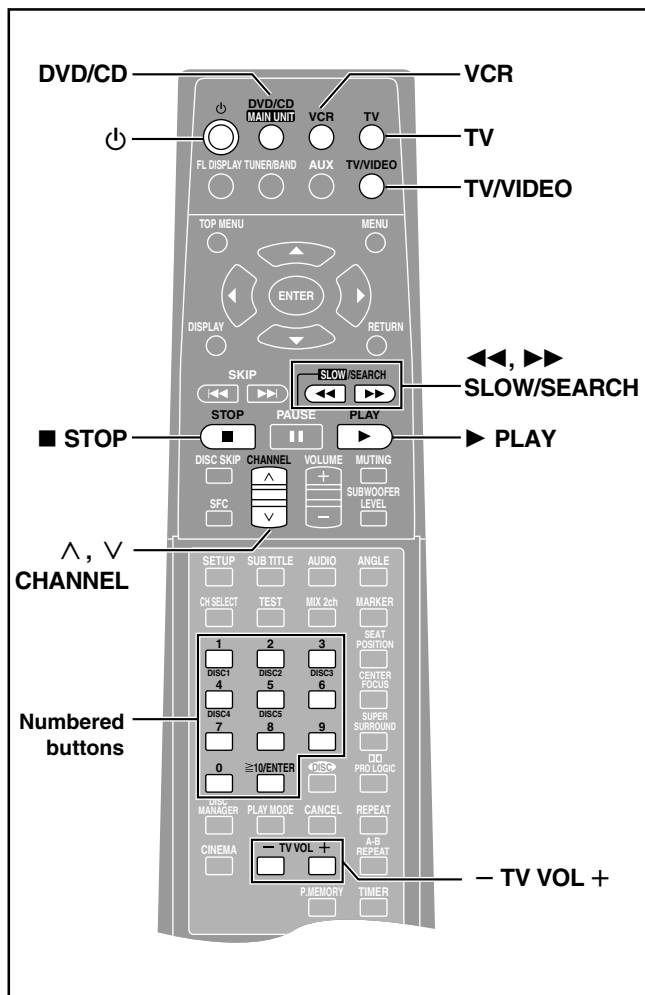

Other functions

Remote control only

Operating a television

Switching to television operation mode

Press [TV].

The button lights.

The main unit also switches to television input.

Turning the television on/off

Press [⏻].

Changing channels

Press [CHANNEL (▲ or ▼)].

You can also select the channel with the numbered buttons.

To select a 2-digit number

Example: To select channel 23, press [≧10/ENTER] → [2] → [3].

Adjusting the volume

Press [TV VOL (- or +)].

Switching the television's video input mode

Press [TV/VIDEO].

Operating a video cassette recorder

Switching to video cassette recorder operation mode

Press [VCR].

The button lights.

The main unit also switches to VCR input.

Turning the video cassette recorder on/off

Press [⏻].

Changing channels

Press [CHANNEL (▲ or ▼)].

Channels 1 to 10 can also be selected with the numbered buttons.

[0] selects channel 10.

Starting play

Press [▶] (PLAY).

Fast-forwarding and rewinding

Press [⏩] or [⏪].

To stop play

Press [■].

Note

- Some models cannot be operated by this remote control.
- To prevent accidental operation, press [DVD/CD] after operation so the unit is ready to operate this unit.

Changing the remote control code

This remote control can operate Panasonic and Technics audiovisual equipment that have remote control sensors. You may need to change the remote control code.

It can also operate some other brands of televisions and video cassette recorders. Check the table for the brand and enter the code as follows.

Aiming the remote control at the television or video cassette recorder, carefully and slowly

While pressing and holding [TV] or [VCR], press the numbered buttons to enter the code number.

The remote control outputs the on/off signal.

If the code is correct, the equipment turns on or off. If it doesn't, try entering another code.

- Note that this remote control cannot operate some equipment and that it may not be able to perform some operations.
- Reenter the codes after you change the batteries.

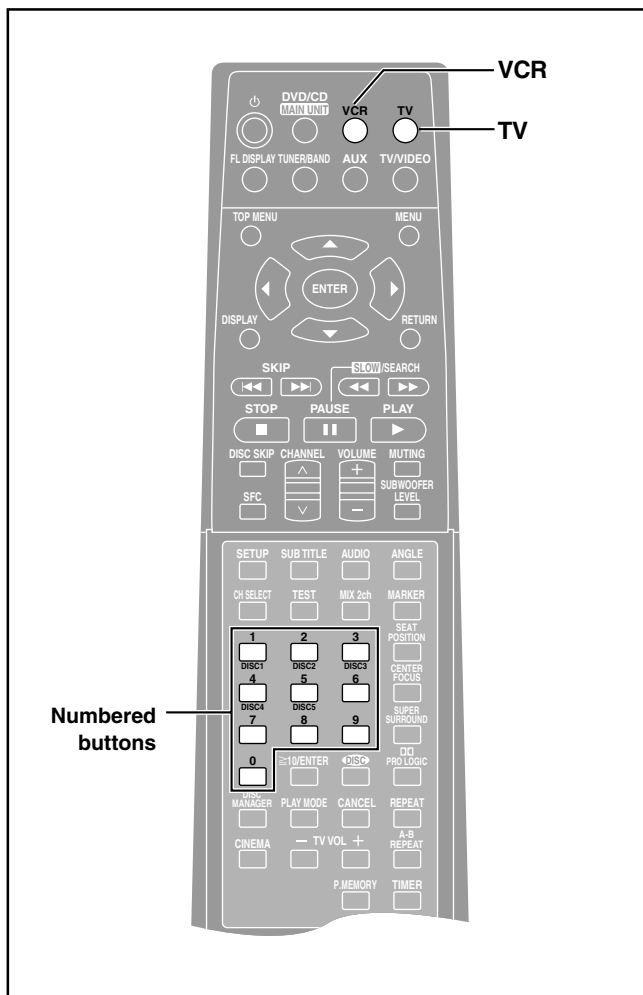

Television code list

Panasonic:	01, 02, 26	Philco:	06, 07
Sony:	04	Philips:	06
Fisher:	14	Pioneer:	02, 10, 19
G-E:	02, 03, 07, 09	Quasar:	02
Gold Star:	07, 15	RCA:	03, 07, 09, 13, 23, 24, 25
Hitachi:	05, 07	Sanyo:	14
JVC:	12	Sharp:	08, 21
LXI:	03, 06, 07, 10, 14, 15	Sylvania:	06, 07, 15
Magnavox:	06, 07, 11, 15, 22	Symphonic:	17
Mitsubishi:	07, 15, 16, 21	Toshiba:	10, 21
NEC:	07, 15	Zenith:	18, 20

Video cassette recorder code list

Panasonic:	01, 02, 09, 33	NEC:	19, 25, 31, 38
Sony:	05, 06, 07, 35, 36, 37	Philco:	02, 09, 12, 30
Fisher:	13, 14, 15, 18, 34	Philips:	02, 09, 12
Funai:	08, 30	Pioneer:	09
G-E:	02, 03, 11	Quasar:	01, 02, 09, 33
Gold Star:	27	RCA:	02, 03, 04, 09, 10, 11, 12, 23, 24, 26
Hitachi:	09, 10, 11	Sanyo:	14, 18, 34
JVC:	19, 25, 31, 38, 39, 40	Sharp:	16, 17
LXI:	10, 13, 14, 15, 18, 27, 30	Shintom:	32
Magnavox:	02, 09, 12	Sylvania:	02, 09, 12, 30
Mitsubishi:	21, 22, 28, 29	Symphonic:	30
		Toshiba:	23, 24
		Zenith:	20

Listening to an external source/Recording to other equipment

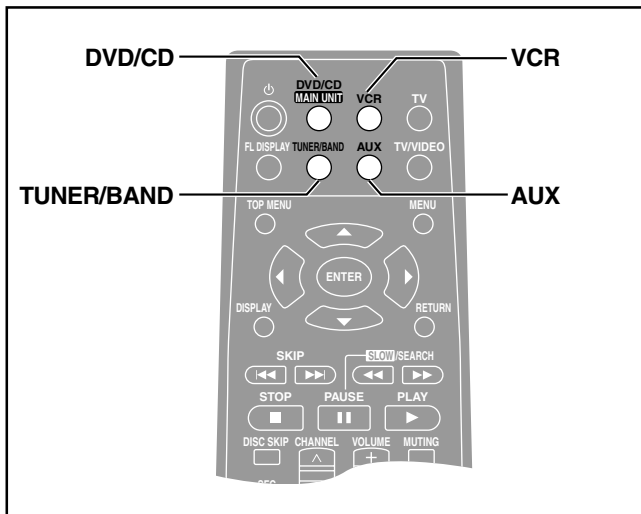

- Turn the unit off before making connections.
- Refer to the manual of the other unit for details. (Cables and equipment not included.)

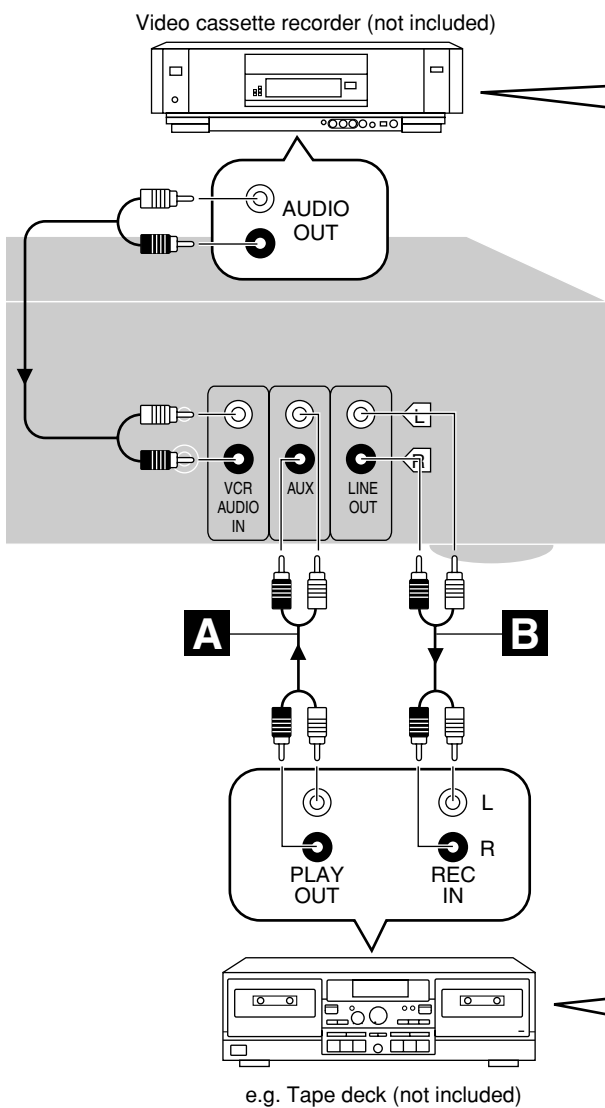
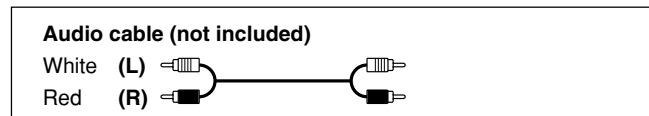

You can playback the sound from a video cassette recorder through this unit's speaker.

- 1 Press [VCR].**
 - Main unit: Press [SELECTOR].
 - Each time you press the button:
DVD/CD → FM → AM → TV → **VCR** → AUX
- 2 Start play.**

A You can playback the sound from a tape deck/laser disc player, etc., through this unit's speaker.

- 1 Press [AUX].**
 - Main unit → see above.
- 2 Start play.**

B You can record sound from the radio or discs, etc. to a tape deck.

- 1**
 - **Disc**
Press [DVD/CD] to select "DVD/CD".
 - **The radio**
Press [TUNER/BAND] to select "FM" or "AM".
 - Main unit → see above.
- 2 Start recording and play.**

When connecting a record player

We recommend using a record player with a built-in phono equalizer. If your player doesn't have a built-in equalizer, connect it first to a separate equalizer and then connect that to this unit.

Optional antenna connections

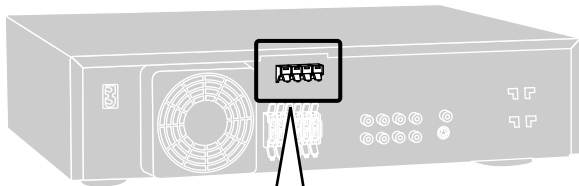

Use outdoor antennas if radio reception is poor.

A FM outdoor antenna (Using a television antenna)

- Disconnect the FM indoor antenna.
- The antenna should be installed by a competent technician.

B AM outdoor antenna (Using a vinyl wire)

- Run a piece of vinyl wire horizontally across a window or other convenient location.
Leave the loop antenna connected.

Note

Disconnect the outdoor antenna when the unit is not in use.
Do not use the outdoor antenna during an electrical storm.

A

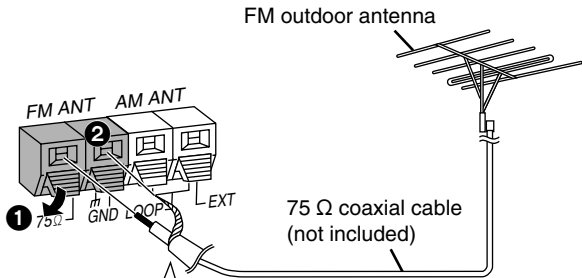

① Remove a piece of the outer insulator.

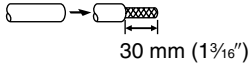

② Twist the shield braid.

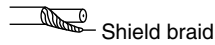

③ Expose the core wire.

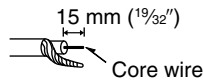

B

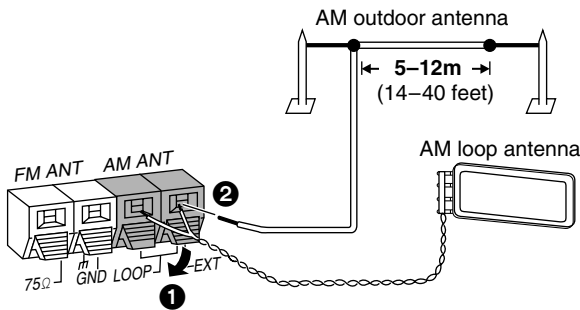

Troubleshooting guide

Before requesting service, make the below checks. If you are in doubt about some of the check points, or if the remedies indicated in the chart do not solve the problem:

Contact the Panasonic Customer Call Center at 1-800-211-7262, or e-mail consumerproducts@panasonic.com, or web site (<http://www.panasonic.com>).

Reference pages are shown as black circled numbers ③.

Power

No power.	● Insert the AC power supply cord securely into the household AC outlet. ③
The unit is automatically switched to the standby mode.	● The unit was switched to standby by the sleep timer. 23

Operation

No response when buttons pressed.	<ul style="list-style-type: none"> ● Some operations may be prohibited by the disc. ● The unit may not be operating properly due to lightning, static electricity or some other external factor. <p>Reset procedure: Press [⏻] to switch the unit to the standby mode and then back to ON. Alternatively, press [⏻] to switch the unit to the standby mode, disconnect the AC power supply cord, and then reconnect it.</p>
No operations can be performed with the remote control.	<ul style="list-style-type: none"> ● Check the batteries are installed correctly. ⑨ ● The batteries are depleted: Replace them with new ones. ⑨ ● Point the remote control at the remote control sensor and operate. ● It may be in the television or video cassette recorder operation mode. Press [DVD/CD] to operate this unit. ● If the remote control doesn't operate the television or video cassette recorder, try changing the code. This remote control cannot operate some televisions or video cassette recorders. 26 27
Play fails to start even when [▶] (PLAY) is pressed. Play starts but then stops immediately.	<ul style="list-style-type: none"> ● Condensation has formed: Wait 1 to 2 hours for it to evaporate. ● This unit cannot play discs other than DVD-Video, CD and Video CD. ⑤ ● This unit cannot play DVD-Video with a region number other than "1", "ALL" or multiple region numbers including "1". ⑤ ● The disc may be dirty and may require cleaning. ⑤ ● Ensure that the disc is installed with the label of the side to be played facing upwards. 11
Alternative languages fail to be selected.	<ul style="list-style-type: none"> ● An alternative language is not selected with discs which do not contain more than one language. ● In the case of some discs, the alternative language cannot be selected with [AUDIO] or [SUB TITLE]. Try selecting it from the disc's menu if one is available. 11
No menu play.	● Menus are only displayed if they are recorded on the disc.
No subtitles.	<ul style="list-style-type: none"> ● Subtitles appear only with discs that contain them. ● Subtitles are cleared from the television. Display the subtitles. 14
Soundtrack and/or subtitle language is not the one selected with the SETUP menus.	● The language is not recorded on the disc.
Angle cannot be changed.	● This function is dependent on software availability. Even if a disc has a number of angles recorded, these angles may be recorded for specific scenes only. 15
The SETUP menu cannot be accessed.	<ul style="list-style-type: none"> ● Select "DVD/CD" as the source. ● Cancel program and random play. 15
You have forgotten your ratings password. Reset all the settings to Factory Preset.	● While stopped, press and hold [■] on the unit and [≥10/ENTER] on the remote control for about 3 seconds until "Initialized" disappears from the television. Turn the unit off and on again. All settings will return to the default values.

Sound

No sound. Distorted sound.	<ul style="list-style-type: none"> ● Check the connections. 7 8 28 ● Turn the volume up. ● Turn muting off. 28 ● Switch off the unit, determine and correct the cause, then switch the unit on. Causes include: <ul style="list-style-type: none"> – Shorting (bare wires touching) of positive and negative speaker wires. 7 – Using speakers with an impedance lower than that rated for this unit. 33 – Straining of the speakers through excessive volume or power. – Using the unit in a hot environment without proper ventilation.
Humming heard during play.	● An AC power supply cord or fluorescent light is near the cables. Keep other appliances and cords away from this unit's cables.
No sound from the subwoofer.	● Check that the subwoofer has not been set to "0". 22

Picture

Picture distorted.	<ul style="list-style-type: none"> • Some distortion is normal during SEARCH.
No picture.	<ul style="list-style-type: none"> • Ensure that the television is connected properly. 8 • Make sure the television is on. • Ensure the television's video input setting (e.g., VIDEO 1) is correct.
The picture shown on the television is not normal. (The sides of the picture are cut off or black bands appear at the top and bottom of the screen.)	<ul style="list-style-type: none"> • Go to the Video menu in the SETUP screen, and change "TV Aspect" to suit your television. You may also need to change the screen mode on the television itself. 9 24 • Ensure that the unit is connected directly to the television, and is not connected through a video cassette recorder.
Picture quality is poor.	<ul style="list-style-type: none"> • Check the settings in the On-Screen Menu Icons' video menu. 17
The picture on the television disappears or stripes appear on the screen.	<ul style="list-style-type: none"> • The location and orientation of the antenna are incorrect. If you are using an indoor antenna, change to an outdoor antenna. 23 The television antenna wire is too close to the unit. Separate the antenna wire of the television from the unit.

Listening to the radio

Noise is heard. The stereo indicator flickers or doesn't light. Sound is distorted.	<ul style="list-style-type: none"> • Adjust the position of the FM or AM antenna. 6 • Use an outdoor antenna. 23
A beat sound is heard.	<ul style="list-style-type: none"> • Turn the television off or separate it from the unit.
A low hum is heard during AM broadcasts.	<ul style="list-style-type: none"> • Separate the antenna from other cables and cords.

Unit displays

This unit's display is off.	<ul style="list-style-type: none"> • Press [FL DISPLAY] to turn the display on. 28
"NO PLAY"	<ul style="list-style-type: none"> • You inserted a disc the unit cannot play; insert one it can. 5
"NO DISC"	<ul style="list-style-type: none"> • You haven't inserted a disc; insert one. • You haven't inserted the disc correctly; insert it correctly. 11
"F61"	<ul style="list-style-type: none"> • Check and correct the speaker cord connections. 7 If this does not fix the problem, there is a power supply problem. Consult the dealer.
"DTS NO AUDIO"	<ul style="list-style-type: none"> • This unit is unable to decode DTS signals.
"DTS CD"	<ul style="list-style-type: none"> • This unit is unable to decode DTS signals.
"DVD U11"	<ul style="list-style-type: none"> • The disc is dirty. Wipe it with a soft cloth. 5
"ERROR"	<ul style="list-style-type: none"> • Incorrect operation performed. Read the instructions and try again.
"DVD H□□" □□ stands for a number.	<ul style="list-style-type: none"> • Trouble is likely to have occurred. The number following "H" depends on the status of the unit. Reset procedure: Press [⏻] to switch the unit to the standby mode and then back to ON. Alternatively, press [⏻] to switch the unit to the standby mode, disconnect the AC power supply cord, and then reconnect it. • If the service numbers fail to clear, note the service number and contact a qualified service person.
"TAKE OUT DISC"	<ul style="list-style-type: none"> • A problem has occurred with the tray mechanism. The tray will open automatically. Take out the disc and close the tray. The unit will make the disc changing noises for a few moments and then should operate normally.

Television displays

No on-screen display.	<ul style="list-style-type: none"> • Go to Display in the SETUP menus, and select "On" for "On-Screen Messages". 24
On-Screen Menu Icons not displayed or only partially displayed on the television.	<ul style="list-style-type: none"> • Press [▲, ▼] while the rightmost icon is highlighted to move them down. 16
The disc's menu is displayed in a different language.	<ul style="list-style-type: none"> • Go to Disc in the SETUP menus, and select the preferred language for "Menus". 24

Maintenance

To clean this unit, wipe with a soft, damp cloth.

- Never use alcohol, paint thinner or benzene to clean this unit.
- Before using chemically treated cloth, read the instructions that came with the cloth carefully.

Bitstream

This is the digital form of multiple channel audio data (e.g., 5.1 channel) before it is decoded into its various channels.

Decoder

A decoder restores the coded audio signals on DVDs to normal. This is called decoding.

Dolby Digital

This is a method of coding digital signals developed by Dolby Laboratories. Apart from stereo (2-channel) audio, these signals can also be 5.1-channel audio. A large amount of audio information can be recorded on one disc using this method.

Dolby Pro Logic

A surround system where a 4-channel audio track is recorded as 2 channels and then is restored to 4 channels for play. The surround channel is monaural and can reproduce up to 7 kHz.

Dynamic range

Dynamic range is the difference between the lowest level of sound that can be heard above the noise of the equipment and the highest level of sound before distortion occurs.

Frame still and field still

Frames are the still pictures that go together to make a moving picture. There are about 30 frames shown each second.

One frame is made up of two fields. A regular television shows these fields one after the other to create frames.

A still is shown when you pause a moving picture. A frame still is made up of two alternating fields, so the picture may appear blurred, but overall quality is high.

A field still is not blurred, but it has only half the information of a frame still so picture quality is lower.

I/P/B

MPEG 2, the video compression standard adopted for use with DVD-Video, codes frames using these 3 picture types.

I: Intra coded picture (I-picture)

This is the standard picture and is a complete picture in itself.

This means it has the best picture quality and is the best to use when adjusting the picture.

P: Predictive coded picture (P-picture)

This picture is calculated based on past I or P-pictures.

B: Bidirectionally-predictive coded picture (B-picture)

This picture is calculated by comparing past and future I and P-pictures so it has the lowest volume of information.

Linear PCM (pulse code modulation)

These are uncompressed digital signals, similar to those found on CDs.

MP3

A method of compressing audio, MPEG Audio Layer 3 (MP3) allows audio to be reduced to up to one tenth its original size without overtly hurting audio quality.

When creating MP3 files to play on this unit

- Disc formats: ISO9660 level 1 and level 2 (except for extended formats)
- Files: MP3 files with the suffix ".mp3" or ".MP3"
- This unit is compatible with multi-session but if there are a lot of sessions it takes more time for play to start. Keep the number of sessions to a minimum to avoid this.
- This unit is not compatible with ID3 tags.
- This unit is not compatible with files with a sampling rate of 32 kHz.

Playback control (PBC)

If a Video CD has playback control, you can select scenes and information with menus.

Language code list

Abkhazian: 6566	Chinese: 9072	Hausa: 7265	Lithuanian: 7684	Romanian: 8279	Telugu: 8469
Afar: 6565	Corsican: 6779	Hebrew: 7387	Macedonian: 7775	Russian: 8285	Thai: 8472
Afrikaans: 6570	Croatian: 7282	Hindi: 7273	Malagasy: 7771	Samoan: 8377	Tibetan: 6679
Albanian: 8381	Czech: 6783	Hungarian: 7285	Malay: 7783	Sanskrit: 8365	Tigrinya: 8473
Ameharic: 6577	Danish: 6865	Icelandic: 7383	Malayalam: 7776	Scots Gaelic: 7168	Tonga: 8479
Arabic: 6582	Dutch: 7876	Indonesian: 7378	Maltese: 7784	Serbian: 8382	Turkish: 8482
Armenian: 7289	English: 6978	Interlingua: 7365	Maori: 7773	Serbo-Croatian: 8372	Turkmen: 8475
Assamese: 6583	Esperanto: 6979	Irish: 7165	Marathi: 7782	Shona: 8378	Twi: 8487
Aymara: 6588	Estonian: 6984	Italian: 7384	Moldavian: 7779	Sindhi: 8368	Ukrainian: 8575
Azerbaijani: 6590	Faroese: 7079	Japanese: 7465	Mongolian: 7778	Singhalese: 8373	Urdu: 8582
Bashkir: 6665	Fiji: 7074	Javanese: 7487	Nauru: 7865	Slovak: 8375	Uzbek: 8590
Basque: 6985	Finnish: 7073	Kannada: 7578	Nepali: 7869	Slovenian: 8376	Vietnamese: 8673
Bengali; Bangla: 6678	French: 7082	Kashmiri: 7583	Norwegian: 7879	Somali: 8379	Volapük: 8679
Bhutani: 6890	Frisian: 7089	Kazakh: 7575	Oriya: 7982	Spanish: 6983	Welsh: 6789
Bihari: 6672	Galician: 7176	Kirghiz: 7589	Pashto, Pushto: 8083	Sundanese: 8385	Wolof: 8779
Breton: 6682	Georgian: 7565	Korean: 7579	Persian: 7065	Swahili: 8387	Xhosa: 8872
Bulgarian: 6671	German: 6869	Kurdish: 7585	Polish: 8076	Swedish: 8386	Yiddish: 7473
Burmese: 7789	Greek: 6976	Laotian: 7679	Portuguese: 8084	Tagalog: 8476	Yoruba: 8979
Byelorussian: 6669	Greenlandic: 7576	Latin: 7665	Punjabi: 8065	Tajik: 8471	Zulu: 9085
Cambodian: 7577	Guarani: 7178	Latvian, Lettish: 7686	Quechua: 8185	Tamil: 8465	
Catalan: 6765	Gujarati: 7185	Lingala: 7678	Rhaeto-Romance: 8277	Tatar: 8484	

AMPLIFIER SECTION

FTC TTL POWER OUTPUT	250 W
120 Hz–20 kHz, 1.0 % total harmonic distortion	
FRONT	28 W per ch (6 Ω)
CENTER	28 W (6 Ω)
SURROUND	28 W per ch (6 Ω)
45 Hz–120 Hz, 1.0 % total harmonic distortion	
SUBWOOFER	110 W (6 Ω)
RMS TTL POWER OUTPUT	350 W
1 kHz, 10 % total harmonic distortion	
FRONT	38 W per ch (6 Ω)
CENTER	38 W (6 Ω)
SURROUND	38 W per ch (6 Ω)
100 Hz, 10 % total harmonic distortion	
SUBWOOFER	160 W (6 Ω)
Input sensitivity/input impedance	
AUX	250 mV, 10 kΩ

FM TUNER SECTION

Frequency range	87.9–107.9 MHz (200 kHz steps) 87.5–108.0 MHz (100 kHz steps)
Sensitivity	16.0 dBf (1.7 μV, IHF)
Antenna terminals	75 Ω unbalanced

AM TUNER SECTION

Frequency range	520–1710 kHz (10 kHz steps)
Sensitivity	
S/N 20 dB at 1000 kHz	600 μV/m

DISC SECTION

Disc	
DVD	8 cm (3")/12 cm (5") single-sided, single-layer 8 cm (3")/12 cm (5") single-sided, double-layer 8 cm (3")/12 cm (5") double-sided, double-layer (One layer per side)
CD/VCD	8 cm (3")/12 cm (5") (CD-R/RW)
Video	
Signal system	NTSC
Output level	Composite video 1 Vp-p (75 Ω)
S-video Y	1 Vp-p (75 Ω)
S-video C	0.286 Vp-p (75 Ω)(NTSC)
Audio	
Sampling frequency	
CD	44.1 kHz
DVD	48 kHz/96 kHz
Decoding	16/20/24 bit linear
Wow and flutter	Below measurable limit
D/A converter	Delta-sigma DAC
Pick up	
Beam Source	Semiconductor Laser
Wavelength	
CD/VCD	790 nm
DVD	658 nm

SPEAKER SECTION

Front and surround speakers SB-AFC95

Type	1 way 1 speaker system Bass-ref.
Full range	8 cm (3 ¹ / ₈ ") cone type
Impedance	6 Ω
Input power	
MUSIC	60 W
Output sound pressure level	79 dB/W (1 m)
Frequency range	80 Hz–22 kHz (–16 dB) 110 Hz–20 kHz (–10 dB)
Dimensions (W×H×D)	88×135×112 mm (3 ¹⁵ / ₃₂ "×5 ¹¹ / ₃₂ "×4 ⁷ / ₁₆ ")
Mass	Approx. 0.8 kg (1.8 lb.)

Center speaker SB-PC89

Type	1 way 1 speaker system Bass-ref.
Full range	8 cm (3 ¹ / ₈ ") cone type
Impedance	6 Ω
Input power	
MUSIC	60 W
Output sound pressure level	79 dB/W (1 m)
Frequency range	80 Hz–22 kHz (–16 dB) 110 Hz–20 kHz (–10 dB)
Dimensions (W×H×D)	135×88×112 mm (5 ¹¹ / ₃₂ "×3 ¹⁵ / ₃₂ "×4 ⁷ / ₁₆ ")
Mass	Approx. 0.8 kg (1.8 lb.)

Subwoofer SB-W95

Type	1 way 1 speaker system Bass-ref.
Woofer	17 cm (6 ³ / ₄ ") cone type
Impedance	6 Ω
Input power	
MUSIC	200 W
Output sound pressure level	80 dB/W (1 m)
Frequency range	42 Hz–1.5 kHz (–16 dB) 46 Hz–900 Hz (–10 dB)
Dimensions (W×H×D)	173×315×300 mm (6 ¹³ / ₁₆ "×12 ¹³ / ₃₂ "×11 ¹³ / ₁₆ ")
Mass	Approx. 4 kg (8.8 lb.)

GENERAL

Power supply	AC 120 V, 60 Hz
Power consumption	190 W
Dimensions (W×H×D)	430×114×368 mm (16 ¹⁵ / ₁₆ "×4 ¹ / ₂ "×14 ¹ / ₂ ")
Mass	Approx. 8.4 kg (18.5 lb.)

Power consumption in standby mode	0.25 W
--	--------

Note

- Specifications are subject to change without notice. Mass and dimensions are approximate.
- Total harmonic distortion is measured by the digital spectrum analyzer.



**For Product Information, Operating Assistance, Literature Request, Dealer Locations, and all Customer Service inquiries please contact:
1-800-211-PANA (7262), Monday–Friday 9 am–9 pm; Saturday–Sunday 9 am–7 pm, EST.**

**Web Site: <http://www.panasonic.com>
You can purchase parts, accessories or locate your nearest servicenter by visiting our Web Site.**

Accessory Purchases:

**1-800-332-5368 (Customer Orders Only)
Panasonic Services Company 20421 84th Avenue South, Kent, WA 98032
(6 am to 5 pm Monday–Friday; 6 am to 10:30 am Saturday; PST)
(Visa, MasterCard, Discover Card, American Express, Check)**

Factory Servicenters Locations

<p>CALIFORNIA 6550 Katella Avenue Cypress, CA 90630</p> <p>800 Dubuque Avenue S. San Francisco CA 94080</p> <p>3878 Ruffin Road Suite A San Diego, CA 92123</p> <p>FLORIDA 3700 North 29th Avenue Suite 102 Hollywood, FL 33020</p>	<p>GEORGIA 8655 Roswell Road Suite 100 Atlanta, GA 30350</p> <p>ILLINOIS 1709 North Randall Road Elgin, IL 60123</p> <p>MASSACHUSETTS 60 Glacier Drive Suite G Westwood, MA 02090</p>	<p>MINNESOTA 7850-12th Avenue South Airport Business Center Bloomington, MN 55425</p> <p>OHIO 2236 Waycross Road Civic Center Plaza Forest Park, OH 45240</p> <p>PENNSYLVANIA 2221 Cabot Blvd. West Suite B Langhorne, PA 19047</p>	<p>TEXAS 13615 Welch Road Suite 101 Farmers Branch TX 75244</p> <p>WASHINGTON 20425-84th Avenue South Kent, WA 98032</p> <p>HAWAII 99-859 Iwaiwa Street Aiea, Hawaii 96701 Phone (808) 488-1996 Fax (808) 486-4369</p>
--	--	---	--

Reference

Service in Puerto Rico

**Matsushita Electric of Puerto Rico, Inc. Panasonic Sales Company/Factory Servicenter:
Ave. 65 de Infanteria, Km. 9.5, San Gabriel Industrial Park, Carolina, Puerto Rico 00985
Phone (787) 750-4300 Fax (787) 768-2910**

Limited Warranty

Panasonic Consumer Electronics Company,
Division of Matsushita Electric Corporation of America
One Panasonic Way Secaucus, New Jersey 07094

Panasonic Sales Company, Division of Matsushita Electric
of Puerto Rico, Inc.
Ave. 65 de Infantería, Km. 9.5
San Gabriel Industrial Park, Carolina, Puerto Rico 00985

Panasonic/Technics Audio Products Limited Warranty

Panasonic Consumer Electronics Company or Panasonic Sales Company (collectively referred to as "the Warrantor") will repair or replace this product with new or refurbished parts or equivalent product, free of charge in the U.S.A. or Puerto Rico, in the event of a defect in materials or workmanship as follows (all time periods commence from the date of original purchase):

AUDIO PRODUCTS—labor and parts for one (1) year.

ALL AUDIO RACKS (cabinets)—parts only 30 days.

TECHNICS STAND ALONE SPEAKERS, SUBWOOFER SPEAKERS—labor and parts for three (3) years.

USB READER-WRITER, PERSONAL COMPUTER CARD ADAPTERS—(when applicable)—exchange defective unit with a new or refurbished one for one (1) year.

ACCESSORIES—HEADPHONES, CARTRIDGES, MICROPHONES, ADAPTERS—labor and parts for ninety (90) days.

RECHARGEABLE BATTERIES—(when applicable)—exchange defective item for new one for ten (10) days. Non-rechargeable batteries are not warranted.

SD MEMORY CARDS, RECHARGEABLE BATTERY PACKS—(when applicable)—exchange defective item for new one for ninety (90) days. Non-rechargeable battery packs are not warranted.

Carry-in or mail-in service in the U.S.A. can be obtained during the warranty period by contacting a Panasonic Services Company (PASC) Factory Servicenter listed in the Servicenter Directory. Or call toll free, 1-800-211-7262 to locate a PASC authorized Servicenter. Carry-in or mail-in service in Puerto Rico can be obtained during the warranty period by calling the Panasonic Sales Company telephone number listed in the Servicenter Directory.

This warranty is extended only to the original purchaser. A purchase receipt or other proof of date of original purchase will be required before warranty service is rendered.

This warranty only covers failures due to defects in materials and workmanship which occur during normal use and does not cover normal wear to the stylus (when applicable) or a dealer installed cartridge or stylus. The warranty does not cover damages which occur in shipment or failures which are caused by products not supplied by the warrantor, or failures which result from accident, misuse, abuse, neglect, mishandling, faulty installation, misapplication, set-up adjustments, maladjustment of consumer controls, improper operation or maintenance, improper antenna, inadequate signal reception or pick-up, alteration, modification, power line surge, improper voltage supply, lightning damage, commercial use, such as; hotel, office, restaurant, or other business or rental use of the product, or service by anyone other than a PASC Factory Servicenter or a PASC authorized Servicenter, or damage that is attributable to acts of God.

LIMITS AND EXCLUSIONS

There are no express warranties except as listed above.

THE WARRANTOR SHALL NOT BE LIABLE FOR INCIDENTAL OR CONSEQUENTIAL DAMAGES RESULTING FROM THE USE OF THIS PRODUCT, OR ARISING OUT OF ANY BREACH OF THIS WARRANTY, INCLUDING WITHOUT LIMITATION, DAMAGE TO TAPES, RECORDS OR DISCS. ALL EXPRESS AND IMPLIED WARRANTIES, INCLUDING THE WARRANTIES OF MERCHANTABILITY, AND FITNESS FOR A PARTICULAR PURPOSE, ARE LIMITED TO THE APPLICABLE WARRANTY PERIOD SET FORTH ABOVE. Some states do not allow the exclusion or limitation of incidental or consequential damages, or limitations on how long an implied warranty lasts, so the above exclusions or limitations may not apply to you.

This warranty gives you specific legal rights and you may also have other rights which vary from state to state.

If a problem with this product develops during or after the warranty period, you may contact your dealer or Servicenter. If the problem is not handled to your satisfaction, then write to the Consumer Affairs Department at the company address indicated above.

If you ship the product

Carefully pack and send it prepaid, adequately insured and preferably in the original carton.

Attach a postage-affixed letter, detailing the complaint, to the outside of the carton.

Do NOT send the product to the Executive or Regional Sales offices. They are NOT equipped to make repairs

Product Service

- 1. Damage requiring service**—The unit should be serviced by qualified service personnel if:
 - (a) The AC power supply cord or AC adaptor has been damaged; or
 - (b) Objects or liquids have gotten into the unit; or
 - (c) The unit has been exposed to rain; or
 - (d) The unit does not operate normally or exhibits a marked change in performance; or
 - (e) The unit has been dropped or the cabinet damaged.
- 2. Servicing**—Do not attempt to service the unit beyond that described in these operating instructions. Refer all other servicing to authorized servicing personnel.
- 3. Replacement parts**—When parts need replacing ensure the servicer uses parts specified by the manufacturer or parts that have the same characteristics as the original parts. Unauthorized substitutes may result in fire, electric shock, or other hazards.
- 4. Safety check**—After repairs or service, ask the servicer to perform safety checks to confirm that the unit is in proper working condition.

The servicer will require all components to service your system.

Therefore, should service ever be necessary, be sure to bring the entire system.

Product information

For product information or assistance with product operation:

Contact the Panasonic Customer Call Center at 1-800-211-7262, or e-mail consumerproducts@panasonic.com, or web site (<http://www.panasonic.com>).

Listening caution



Selecting fine audio equipment such as the unit you've just purchased is only the start of your musical enjoyment. Now it's time to consider how you can maximize the fun and excitement your equipment offers. This manufacturer and the Electronic Industries Association's Consumer Electronics Group want you to get the most out of your equipment by playing it at a safe level. One that lets the sound come through loud and clear without annoying blaring or distortion—and, most importantly, without affecting your sensitive hearing.

We recommend you to avoid prolonged exposure to excessive noise.

Sound can be deceiving. Over time your hearing "comfort level" adapts to higher volumes of sound. So what sounds "normal" can actually be loud and harmful to your hearing.

Guard against this by setting your equipment at a safe level BEFORE your hearing adapts.

To establish a safe level:

- Start your volume control at a low setting.
- Slowly increase the sound until you can hear it comfortably and clearly, and without distortion.

Once you have established a comfortable sound level:

- Set the dial and leave it there.

Taking a minute to do this now will help to prevent hearing damage or loss in the future. After all, we want you listening for a lifetime.

User memo:

DATE OF PURCHASE _____
DEALER NAME _____
DEALER ADDRESS _____

TELEPHONE NUMBER _____

The model number and serial number of this product can be found on either the back or the bottom of the unit. Please note them in the space provided below and keep for future reference.

MODEL NUMBER _____
SERIAL NUMBER _____

Manufactured under license from Dolby Laboratories.
"Dolby", "Pro Logic" and the double-D symbol are trademarks of Dolby Laboratories.

Apparatus Claims of U.S. Patent Nos. 4,631,603, 4,577,216, and 4,819,098, licensed for limited viewing uses only.

This product incorporates copyright protection technology that is protected by method claims of certain U.S. patents and other intellectual property rights owned by Macrovision Corporation and other rights owners. Use of this copyright protection technology must be authorized by Macrovision Corporation, and is intended for home and other limited viewing uses only unless otherwise authorized by Macrovision Corporation. Reverse engineering or disassembly is prohibited.

Panasonic Consumer Electronics Company, Division of Matsushita Electric Corporation of America

One Panasonic Way Secaucus,
New Jersey 07094
<http://www.panasonic.com>

Panasonic Sales Company, Division of Matsushita Electric of Puerto Rico, Inc. ("PSC")

Ave. 65 de Infantería, Km. 9.5
San Gabriel Industrial Park, Carolina,
Puerto Rico 00985

